













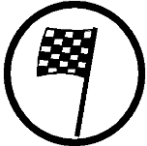



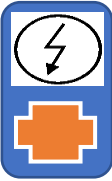

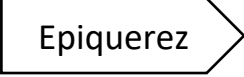





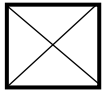

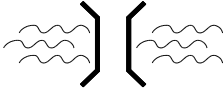

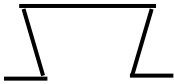











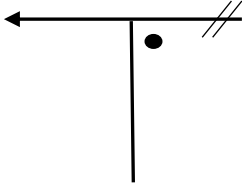

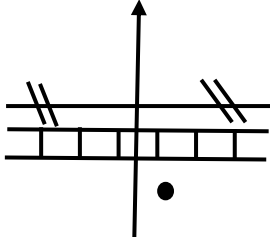
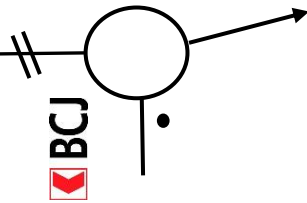

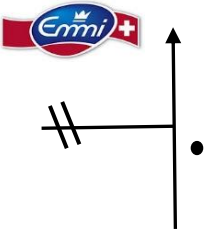
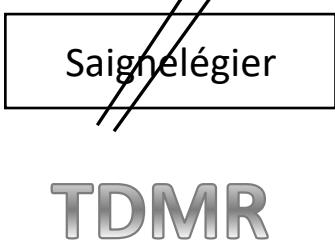
Symbole	Signification	Symbole	Signification
	Contrôle horaire		Zone de casquage
	Départ d'épreuve		Point Stop
	Arrivée épreuve spéciale		Poste commissaire
	Epreuve spéciale	 	route goudronnée chemin en gravier
	Chicane		Secours
	Ne pas suivre cette direction		Direction à suivre
 	Début de localité	 	Fin de localité
	Tout droit sur même route		Danger

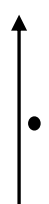
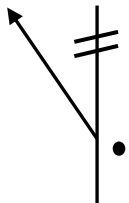
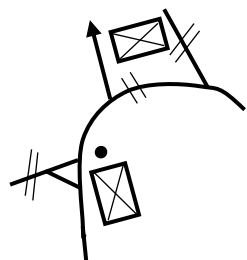
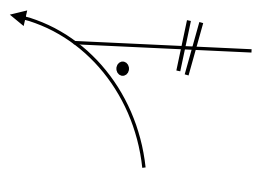
	Maison		Ferme
	Passage à niveau		Pont
	Passage dans un tunnel		Passage sous un pont
	Eglise		Croix
	Arbre		Céder le passage
	balle ronde de paille		Podium
	Reconnaisances à pieds		Restaurant
	Bovi-stop	JUMP	Saut dangereux

Parc d'assistance			Secteur X
Schakedown			
Distance (Km)		Temps (min)	Vitesse (km/h)
Kilométrage Total Partiel		DIRECTION	INFORMATION
			Distance totale

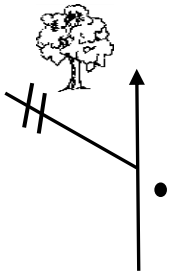
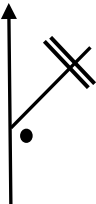

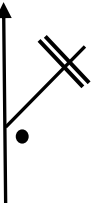
0,000	0,000			10,850
0,040	0,040			10,810
0,190	0,150			10,660
0,260	0,070			10,590
1,130	0,870			9,720





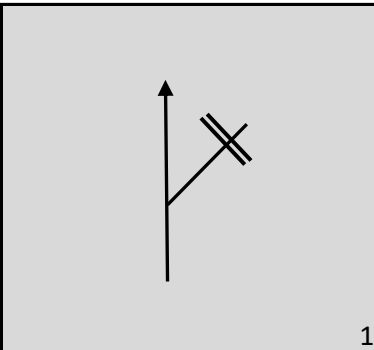

Parc d'assistance				Secteur X
Schakedown				
Distance (Km)		Temps (min)	Vitesse (km/h)	
Kilométrage		DIRECTION	INFORMATION	Distance totale
Total	Partiel			
1,460	0,330		<div style="border: 1px solid black; padding: 5px; display: inline-block;">Le Bémont</div> TDMR	9,390
4,810	3,350		<div style="border: 1px solid black; padding: 5px; display: inline-block;">Montfaucon</div> TDMR	6,040
5,870	1,060		<div style="border: 1px solid black; padding: 5px; display: inline-block;">Les Enfers</div>	4,980
6,770	0,900			4,080
6,870	0,100		<div style="display: flex; align-items: center;"> <div style="border: 1px solid black; padding: 2px; margin-right: 5px;"> <p style="font-size: 8px;">pour votre sécurité</p>  <p style="font-size: 8px;">CONTRÔLES RADARS FRÉQUENTS</p> </div> <div style="border: 1px solid black; padding: 5px; margin-right: 5px;"> <p style="font-weight: bold; font-size: 12px;">ZONE</p> <div style="border: 2px solid red; border-radius: 50%; width: 40px; height: 40px; display: flex; align-items: center; justify-content: center; margin: 0 auto;"> <p style="font-weight: bold; font-size: 24px; color: red;">30</p> </div> <p style="font-weight: bold; font-size: 12px;">km</p> </div> </div> TDMR	3,980

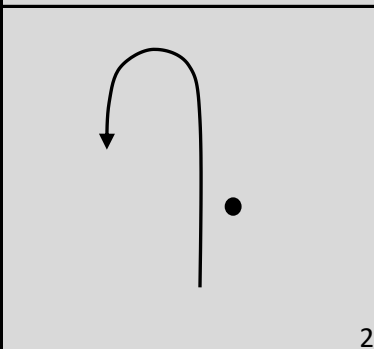
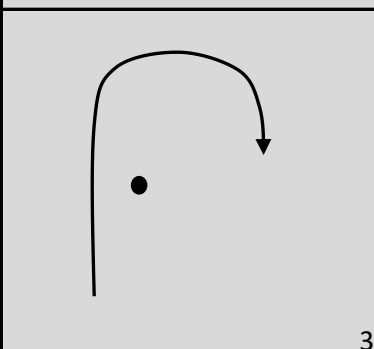
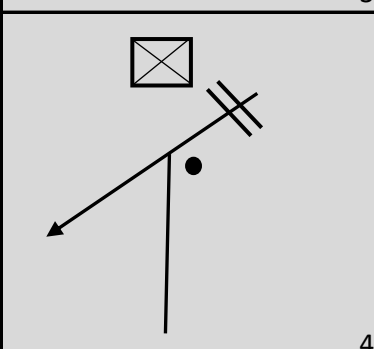
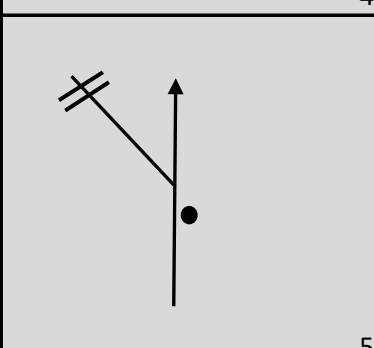
Parc d'assistance				Secteur X
Schakedown				
Distance (Km)		Temps (min)	Vitesse (km/h)	
Kilométrage		DIRECTION	INFORMATION	Distance totale
Total	Partiel			
7,380	0,510	 11	TDMR	3,470
10,120	2,740	 12	TDMR	0,730
10,220	0,100	 13		0,630
10,850	0,630	 14	 	0,000

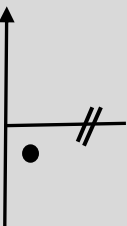

Shakedown			Secteur X
Distance (Km)		Temps (min)	Vitesse (km/h)
Kilométrage Total Partiel		DIRECTION	INFORMATION
			Distance totale

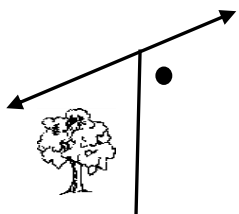
0,000	0,000	 1	 	5,440
0,590	0,590	 2		4,850
0,970	0,380	 3		4,470
1,750	0,780	 4		3,690
2,660	0,910	 5		2,780

Shakedown			Secteur
			X
Distance (Km)		Temps (min)	Vitesse (km/h)
Kilométrage		DIRECTION	INFORMATION
Total	Partiel		Distance totale
2,860	0,200	 6	  2,580
2,940	0,280	 7	  2,500
5,440	2,500	 8	  0,000

44^{ème} Critérium Jurassien

Horaire théorique vendredi 31 mars 2023 1^{ère} Etape (section 1)

CH / ES	Lieu	Longueur ES	Longueur Liaison	Longueur Totale	Temps Imparti	Route fermée	1 ^{ère} VHC	1 ^{ère} moderne	60e moderne	VHRS	Route ouverte
CH 0	Départ						00:00	00:07	00:59	00:05	
CH 1	Courtemauroy		32,910	32,910	00:45		18:00	18:38	19:37		
ES 1	Courtemauroy - Les Enfers	29,860			00:03	16:45	18:45	19:23	20:22		
CH 1A	Entrée parc assistance Saignelégier		7,160	37,020	00:45		18:48	19:26	20:25	20:30	21:30
Assistance Saignelégier					00:30		19:33	20:11	21:10		
CH 1B	Sortie parc d'assistance Saignelégier		0,000				20:03	20:41	21:40		
CH 1B	Entrée au parc fermé Saignelégier				00:00		20:03	20:41	21:40		

Section 1

Horaire théorique samedi 1er avril 2023 2^{ème} Etape (Section 2, 3, 4 et 5)

CH / ES	Lieu	Longueur ES	Longueur Liaison	Longueur Totale	Temps Imparti	Route fermée	1 ^{ère} VHC	1 ^{ère} moderne	60e moderne	VHRS	Route ouverte
CH 1C	Sortie parc fermé Saignelégier						00:00	00:07	00:59	00:05:00	
CH 1C	Entrée parc d'assistance Saignelégier		0,000	0,000	00:00		07:00	07:38	08:37		
Assistance Saignelégier					00:15		07:00	07:38	08:37		
CH 1D	Sortie parc d'assistance Saignelégier						07:15	07:53	08:52		
CH 2	Alle		34,570	34,570	00:45		08:00	08:38	09:37		
ES 2	Alle - Vendlincourt	9,230			00:03	06:00	08:03	08:41	09:40	09:45	18:30
CH 3	St-Brais		28,070	37,300	00:40		08:43	09:21	10:20		
ES 3	St-Brais - Saulcy	7,130			00:03	06:45	08:46	09:24	10:23	10:28	19:15
CH 4	Pré-Petitjean		21,370	28,500	00:40		09:26	10:04	11:03		
ES 4	Pré-Petitjean - Le Bémont	9,460			00:03	07:15	09:29	10:07	11:06	11:11	19:45
CH 4A	Entrée regroupement Saignelégier		2,090	11,550	00:15		09:44	10:22	11:21		
CH 4B	Sortie regroupement Saignelégier				00:40		10:24	11:02	12:01		
CH 4B	Entrée parc d'assistance Saignelégier				00:00		10:24	11:02	12:01		
Assistance Saignelégier					00:30		10:54	11:32	12:31		
CH 4C	Sortie parc d'assistance Saignelégier						10:54	11:32	12:31		
CH 5	Alle		34,570	34,570	00:45		11:39	12:17	13:16		
ES 5	Alle - Vendlincourt	9,230			00:03	06:00	11:42	12:20	13:19	13:24	18:30
CH 6	Les Malettes		13,970	23,200	00:30		12:12	12:50	13:49		
ES 6	SS les Rangiers	10,470			00:03	10:00	12:15	12:53	13:52	13:57	15:00
CH 7	St-Brais		13,730	24,200	00:35		12:50	13:28	14:27		
ES 7	St-Brais - Saulcy	7,130			00:03	06:45	12:53	13:31	14:30	14:35	19:15
CH 8	Pré-Petitjean		21,370	28,500	00:40		13:33	14:11	15:10		
ES 8	Pré-Petitjean - Le Bémont	9,460			00:03	07:15	13:36	14:14	15:13	15:18	19:45
CH 8A	Entrée regroupement Saignelégier		2,090	11,550	00:15		13:51	14:29	15:28		
CH 8B	Sortie regroupement Saignelégier				00:40		14:31	15:09	16:08		
CH 8B	Entrée parc d'assistance Saignelégier				00:00		14:31	15:09	16:08		
Assistance Saignelégier					00:30		15:01	15:39	16:38		
CH 8C	Sortie parc d'assistance Saignelégier						15:01	15:39	16:38		
CH 9	Alle		34,570	34,570	00:45		15:46	16:24	17:23		
ES 9	Alle - Vendlincourt	9,230			00:03	06:00	15:49	16:27	17:26	17:31	18:30
CH 10	St-Brais		28,070	37,300	00:40		16:29	17:07	18:06		
ES 10	St-Brais - Saulcy	7,130			00:03	06:45	16:32	17:10	18:09	18:14	19:15
CH 11	Pré-Petitjean		21,370	28,500	00:40		17:12	17:50	18:49		
ES 11	Pré-Petitjean - Saignelégier	11,970			00:03	07:15	17:15	17:53	18:52		19:45
CH 11A	Arrivée finale		0,260	12,230	00:15		17:30	18:08	19:07		

Section 2







Section 2



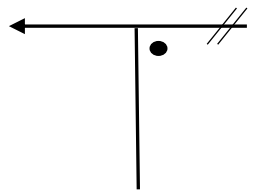

Section 5

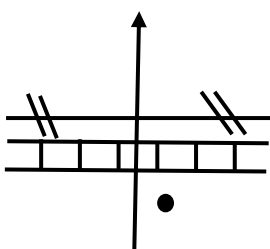
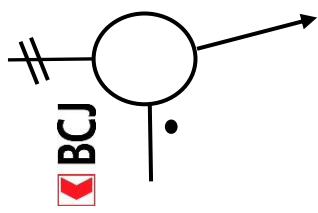

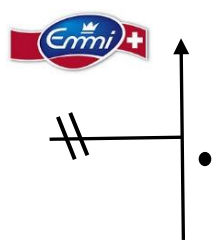
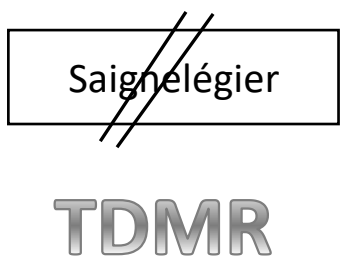

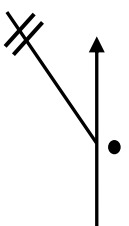
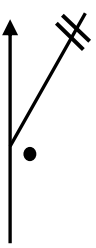

	ES	Liaisons	Total
Vendredi 31 mars 2023	29,860	40,070	<u>69,930</u>
Samedi 1er avril 2023	90,440	256,100	<u>346,540</u>
Total	120,300	296,170	416,470



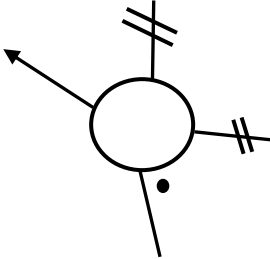
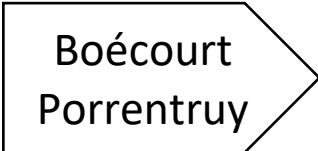
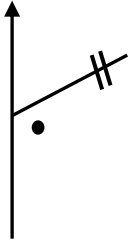

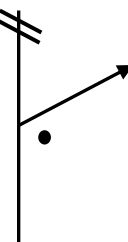
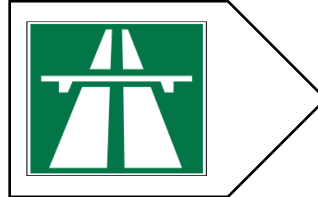
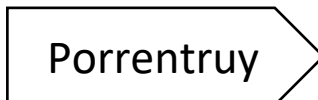
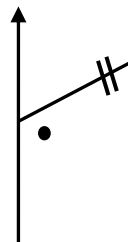

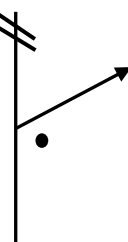
Etape 1

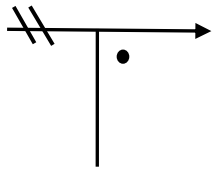
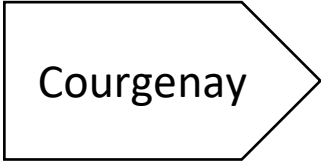

CH 0 Saignelégier			Secteur 0
CH 1 Courtemaury			
Distance (Km) 32,910	Temps (min) 45'	Vitesse (km/h) 43,880	
Kilométrage Total Partiel	DIRECTION	INFORMATION	Distance totale

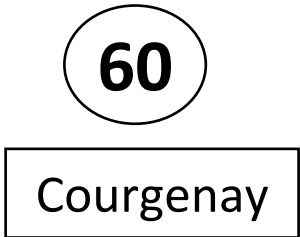
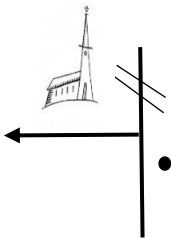
0,000	0,000	 1		32,910
0,040	0,040	 2		32,870
0,190	0,150	 3		32,720
0,260	0,070	 4		32,650
1,130	0,870	 5		31,780

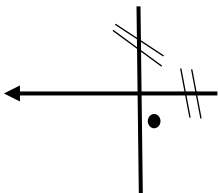
CH 0 Saignelégier			Secteur 0	
CH 1 Courtemaury				
Distance (Km) 32,910	Temps (min) 45'	Vitesse (km/h) 43,880		
Kilométrage Total Partiel		DIRECTION	INFORMATION	Distance totale
1,460	0,330		<div style="border: 1px solid black; padding: 5px; display: inline-block;">Le Bémont</div> TDMR	31,450
4,810	3,350		<div style="border: 1px solid black; padding: 5px; display: inline-block;">Montfaucon</div> TDMR	28,100
10,560	5,750		<div style="border: 1px solid black; padding: 5px; display: inline-block;">St-Brais</div> TDMR	22,350
13,970	3,410		<div style="border: 1px solid black; padding: 5px; display: inline-block;">Delémont</div> TDMR	18,940
18,500	4,530		 <div style="border: 1px solid black; padding: 5px; display: inline-block;">Delémont</div> <div style="border: 1px solid black; padding: 5px; display: inline-block; opacity: 0.5;">Glövelier</div>	14,410

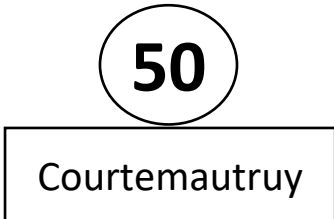
CH 0 Saignelégier			Secteur 0	
CH 1 Courtemaury				
Distance (Km) 32,910	Temps (min) 45'	Vitesse (km/h) 43,880		
Kilométrage Total Partiel		DIRECTION	INFORMATION	Distance totale
20,550	2,050	 11	 Boécourt Porrentruy	12,360
20,710	0,160	 12	  Delémont	12,200
20,810	0,100	 13	  Porrentruy	12,100
24,510	3,700	 14	 St-Ursanne	8,400
29,310	4,800	 15	 Courgenay	3,600

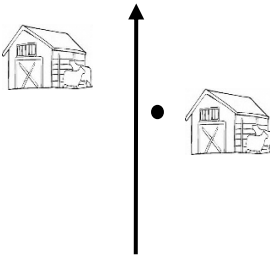
CH 0 Saignelégier			Secteur 0	
CH 1 Courtemaury				
Distance (Km) 32,910		Temps (min) 45'		Vitesse (km/h) 43,880
Kilométrage Total Partiel		DIRECTION	INFORMATION	Distance totale
29,840	0,530	 16		3,070
30,390	0,550	 17		2,520
31,370	0,980	 18		1,540
31,460	0,090	 19		1,450
32,560	1,100	 20		0,350

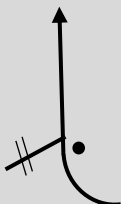
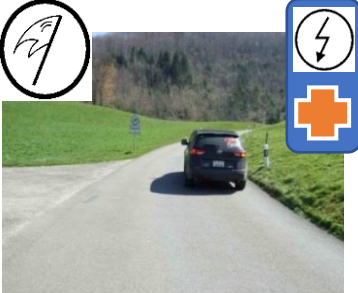





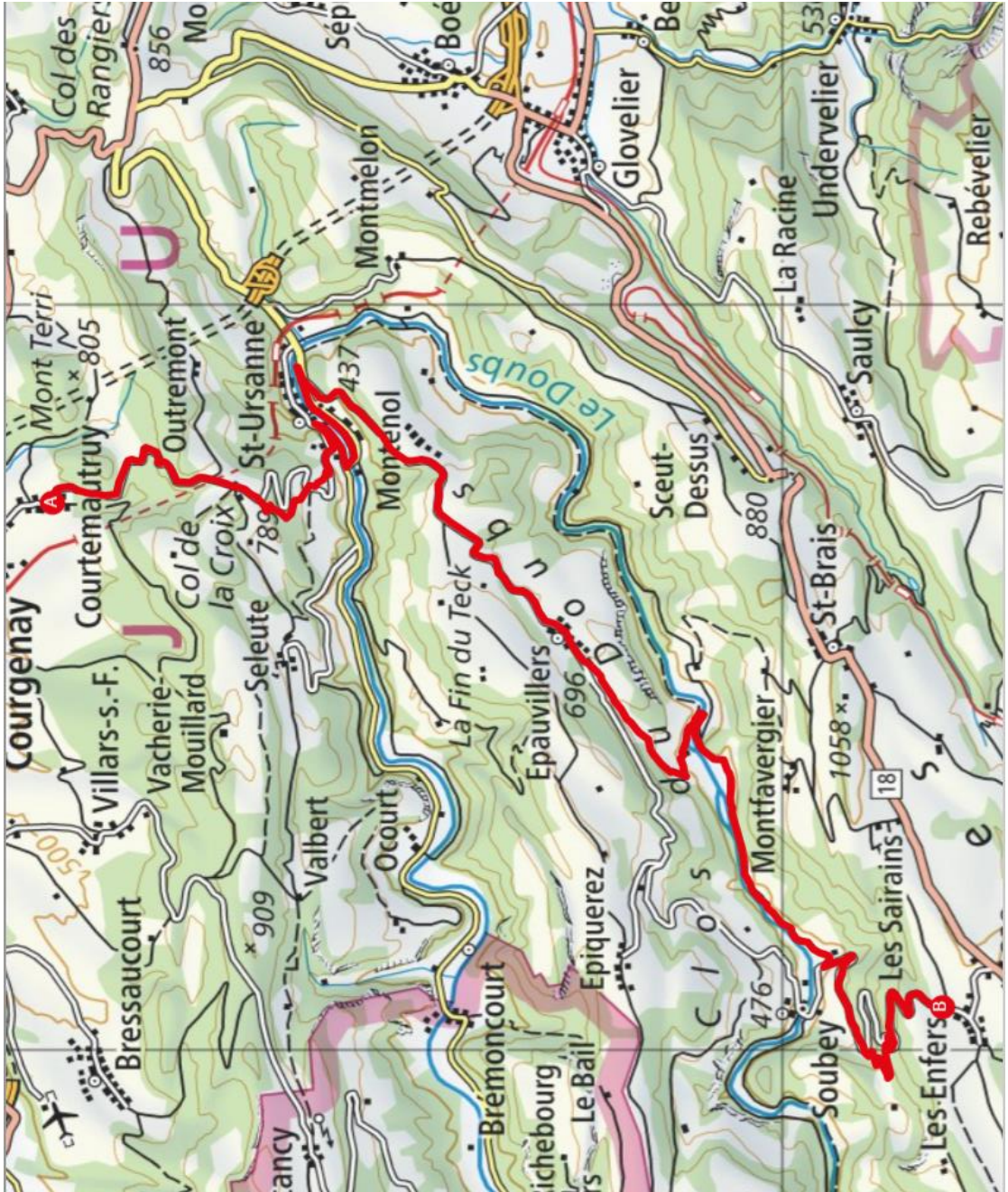

CH 0 Saignelégier			Secteur 0
CH 1 Courtemaury			
Distance (Km) 32,910		Temps (min) 45'	Vitesse (km/h) 43,880
Kilométrage Total Partiel		DIRECTION	INFORMATION
32,910	0,350	 21	
	0,300	 22	

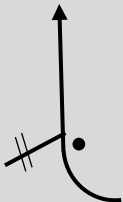
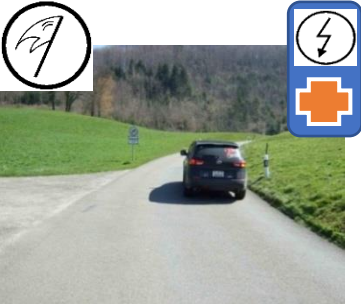

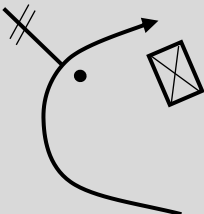

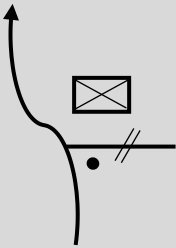

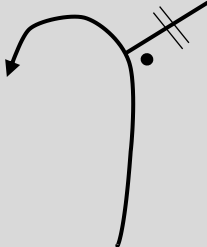



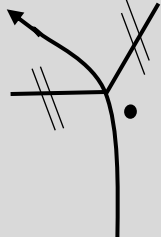

Courtemaury - Les Enfers

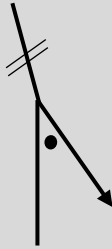

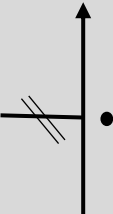







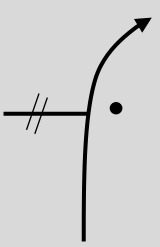

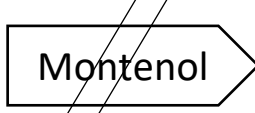
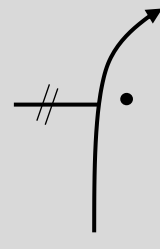

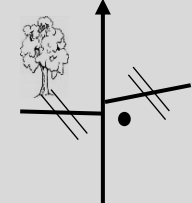

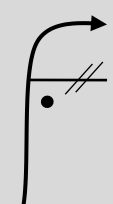

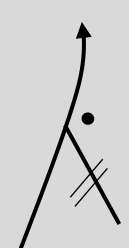



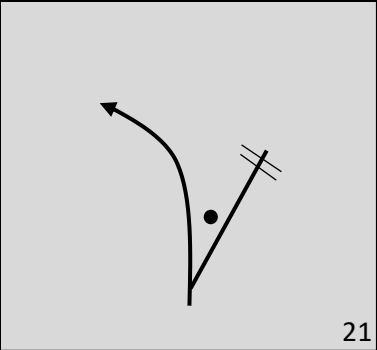

ES 1 Courtemautruy - Les Enfers			Secteur 1
CH 1A Entrée assistance Saignelégier			
Distance (Km) 37,020	Temps (min) 45'	Vitesse (km/h) 49,36	
Kilométrage Total Partiel	DIRECTION	INFORMATION	Distance totale

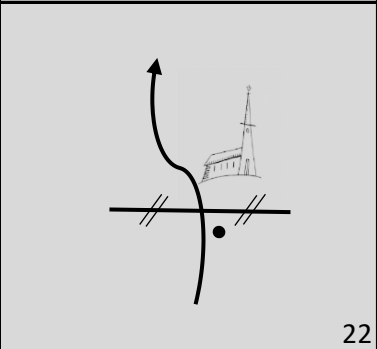

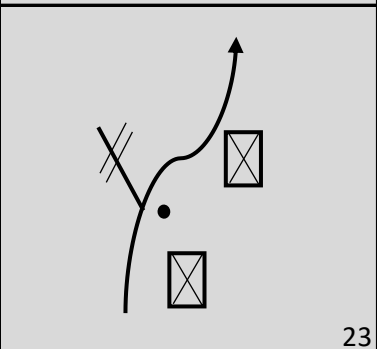

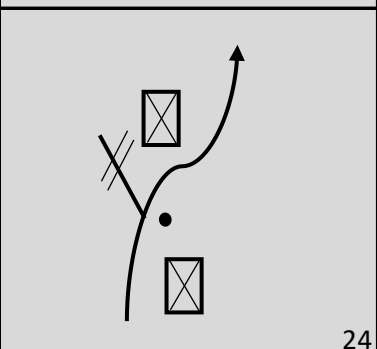

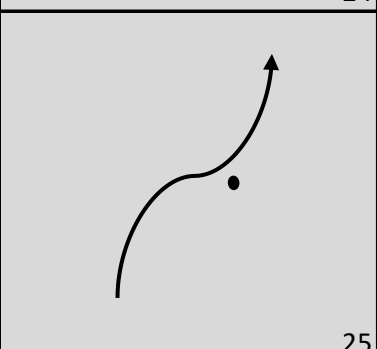

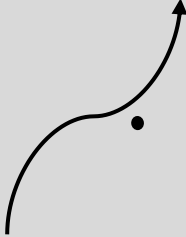

0,000	0,000			37,020
0,900	0,900			36,120
1,610	0,710			35,410
3,100	1,490		 Jump <div style="border: 1px solid black; padding: 2px; display: inline-block;">Col de la Croix</div>	33,920
4,370	1,270			32,650

ES 1 Courtemautruy - Les Enfers			Secteur 1	
CH 1A Entrée assistance Saignelégier				
Distance (Km) 37,020		Temps (min) 45'		Vitesse (km/h) 49,36
Kilométrage Total Partiel		DIRECTION	INFORMATION	Distance totale
5,430	1,060	 6		31,590
6,310	0,880	 7		30,710
6,800	0,490	 8	 	30,220
6,980	0,180	 9		30,040
7,130	0,150	 10		29,890

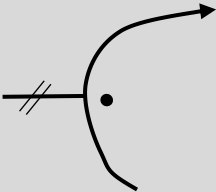

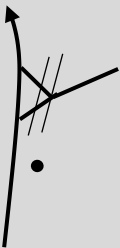

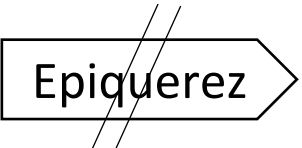
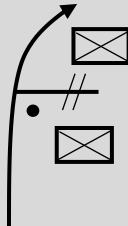





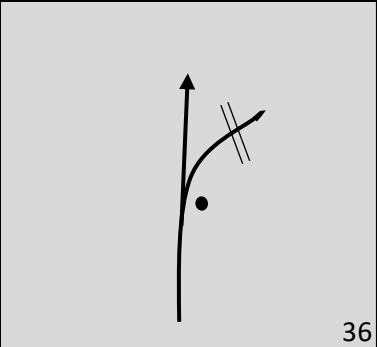

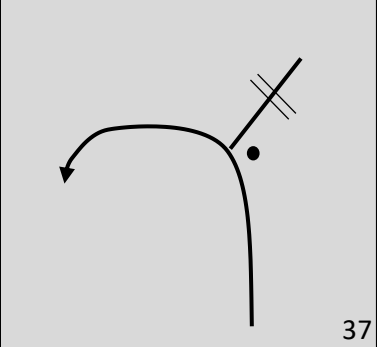

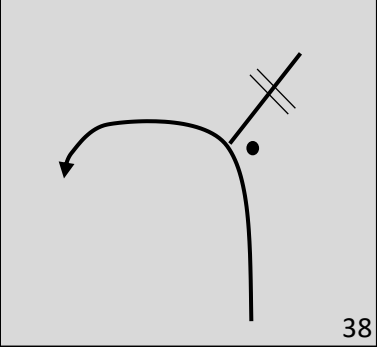
ES 1 Courtemautruy - Les Enfers			Secteur 1	
CH 1A Entrée assistance Saignelégier				
Distance (Km) 37,020		Temps (min) 45'		Vitesse (km/h) 49,36
Kilométrage Total Partiel		DIRECTION	INFORMATION	Distance totale
7,530	0,400	 11		29,490
7,710	0,180	 12		29,310
8,050	0,340	 13		28,970
8,570	0,520	 14		28,450
9,160	0,590	 15	 	27,860

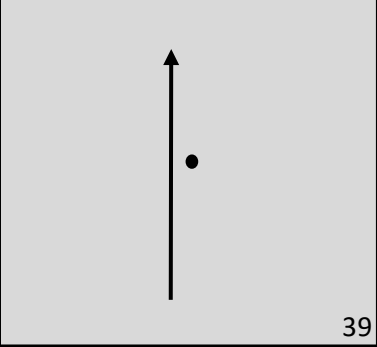
ES 1 Courtemautruy - Les Enfers			Secteur 1	
CH 1A Entrée assistance Saignelégier				
Distance (Km) 37,020		Temps (min) 45'		Vitesse (km/h) 49,36
Kilométrage Total Partiel		DIRECTION	INFORMATION	Distance totale
11,430	2,270	 16	 	25,590
11,750	0,320	 17		25,270
12,490	0,740	 18		24,530
13,460	0,970	 19		23,560
14,560	1,100	 20		22,460

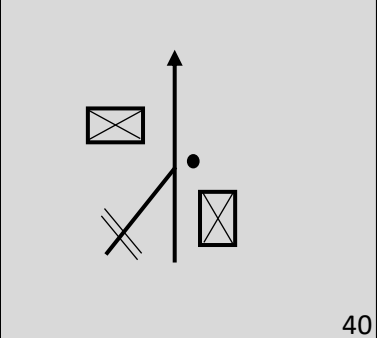

ES 1 Courtemautruy - Les Enfers			Secteur 1	
CH 1A Entrée assistance Saignelégier				
Distance (Km) 37,020		Temps (min) 45'		Vitesse (km/h) 49,36
Kilométrage Total Partiel		DIRECTION	INFORMATION	Distance totale
14,700	0,140	 21	  	22,320
14,870	0,170	 22	 	22,150
14,960	0,090	 23	 	22,060
15,370	0,410	 24		21,650
15,960	0,590	 25		21,060



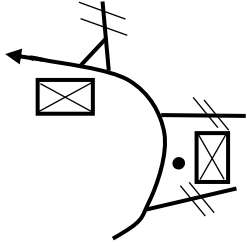
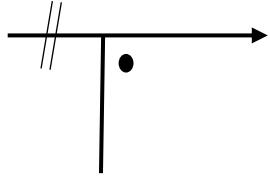

ES 1 Courtemaury - Les Enfers			Secteur 1	
CH 1A Entrée assistance Saignelégier				
Distance (Km) 37,020	Temps (min) 45'	Vitesse (km/h) 49,36		
Kilométrage Total Partiel		DIRECTION	INFORMATION	Distance totale
16,660	0,700	 26		20,360
17,660	1,000	 27		19,360
18,170	0,510	 28		18,850
18,750	0,580	 29	 	18,270
19,120	0,370	 30	 	17,900

ES 1 Courtemautruy - Les Enfers			Secteur 1
CH 1A Entrée assistance Saignelégier			
Distance (Km) 37,020		Temps (min) 45'	Vitesse (km/h) 49,36
Kilométrage Total Partiel		DIRECTION	INFORMATION
			Distance totale
20,520	1,400	 31	 16,500
21,330	0,810	 32	 15,690
22,540	1,210	 33	 14,480
22,750	0,210	 34	 14,270
23,430	0,680	 35	 13,590

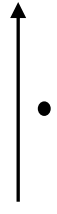
ES 1 Courtemautruy - Les Enfers			Secteur 1
CH 1A Entrée assistance Saignelégier			
Distance (Km) 37,020		Temps (min) 45'	Vitesse (km/h) 49,36
Kilométrage Total Partiel		DIRECTION	INFORMATION
			Distance totale
24,680	1,250	 36	 12,340
25,410	0,730	 37	  11,610
28,540	3,130	 38	 8,480
29,120	0,580	 39	   7,900
29,860	0,740	 40	   7,160

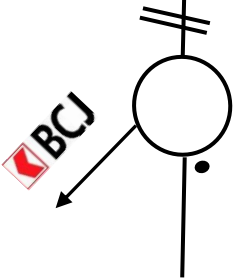
ES 1 Courtemautruy - Les Enfers			Secteur 1
CH 1A Entrée assistance Saignelégier			
Distance (Km) 37,020	Temps (min) 45'	Vitesse (km/h) 49,36	
Kilométrage Total Partiel		DIRECTION	INFORMATION
			Distance totale

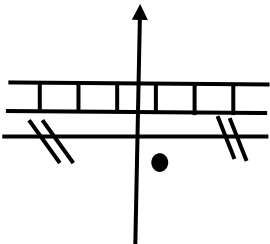
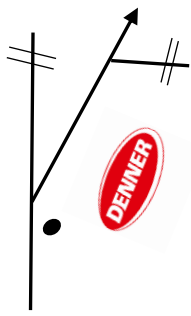
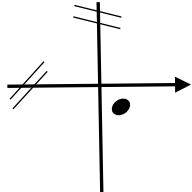
30,130	0,270	 41		6,890
31,000	0,870	 42	Saignelégier TDMR	6,020
34,680	3,680	 43	Le Bémont TDMR	2,340
35,840	1,160	 44	Saignelégier TDMR	1,180

ES 1 Courtemautruy - Les Enfers			Secteur 1	
CH 1A Entrée assistance Saignelégier				
Distance (Km) 37,020	Temps (min) 45'	Vitesse (km/h) 49,36		
Kilométrage Total Partiel		DIRECTION	INFORMATION	Distance totale
36,770	0,930			0,250
36,840	0,070			0,180
36,880	0,040			0,140
37,020	0,140			0,000

CH 1 A Entrée assistance Saignelégier			Secteur 1A
CH 1 B Sortie assistance Saignelégier, entrée parc fermé			
Distance (Km)	Temps (min) 30'	Vitesse (km/h)	







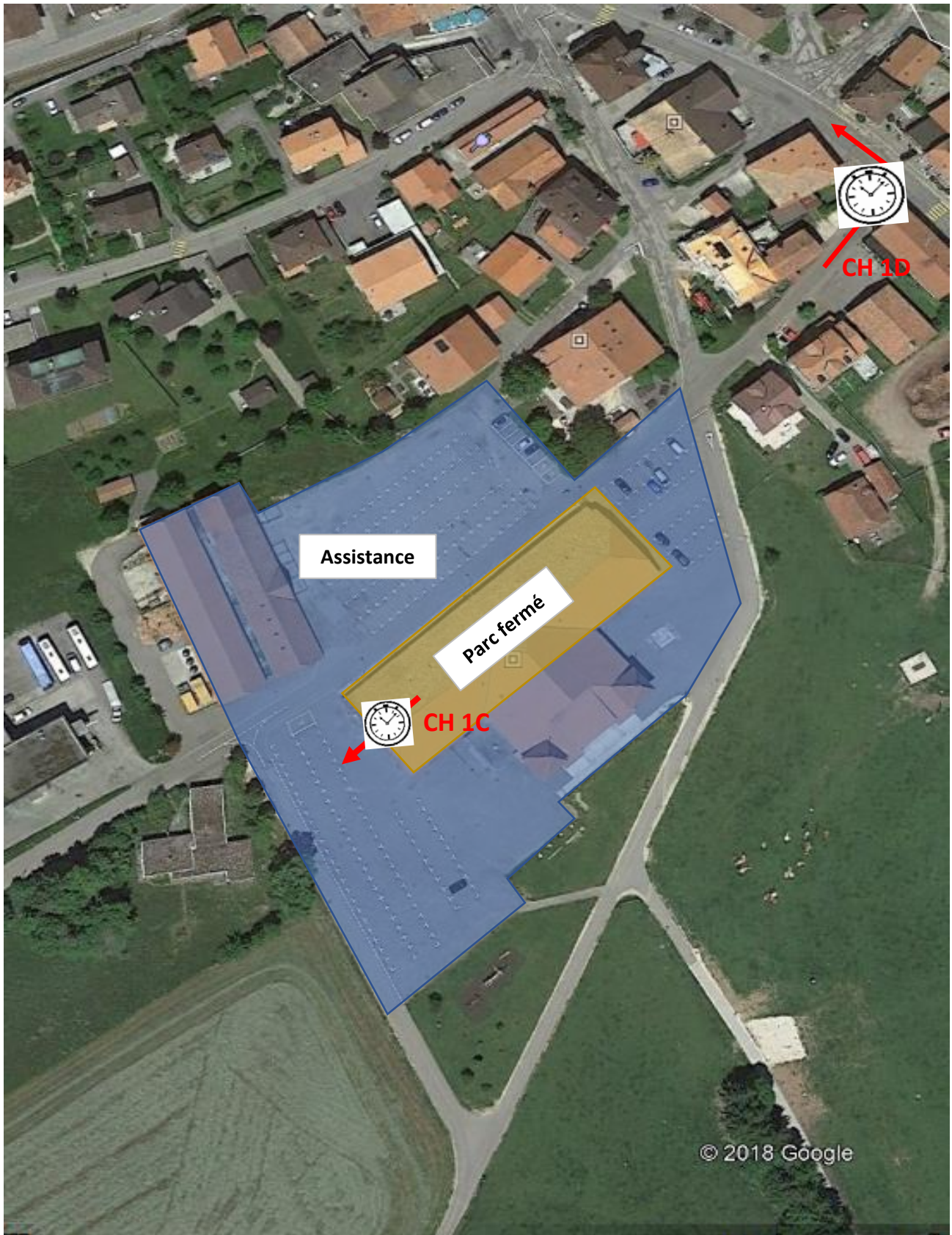





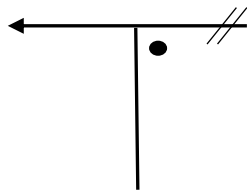

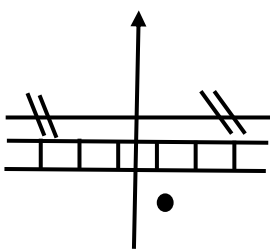
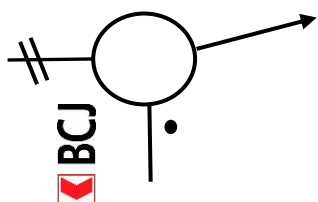
Etape 2

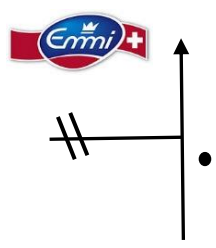



CH 1C Sortie regroupement entrée assistance Saignelégier			Secteur 1C
CH 1D Sortie assistance Saignelégier			
Distance (Km)	Temps (min) 15'	Vitesse (km/h)	

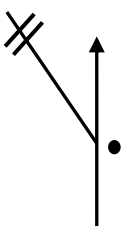
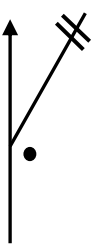



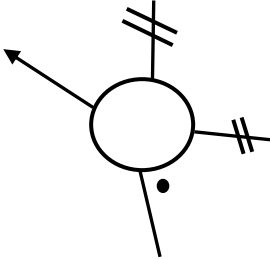
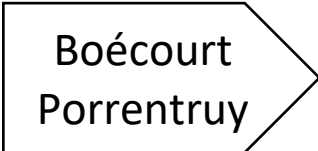
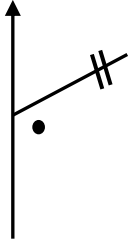

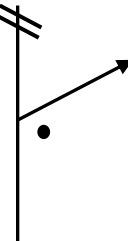
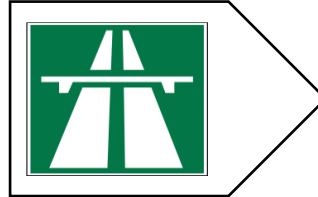
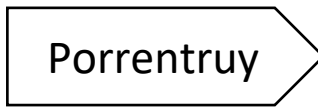
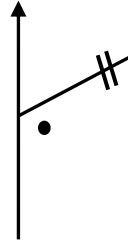
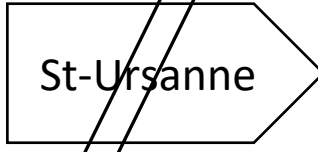
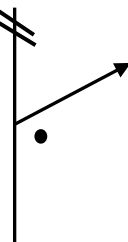
CH 1D Saignelégier			Secteur 1D
CH 2 Alle			
Distance (Km) 34,570	Temps (min) 45'	Vitesse (km/h) 46,093	
Kilométrage Total Partiel	DIRECTION	INFORMATION	Distance totale

0,000	0,000			34,570
0,040	0,040			34,530
0,190	0,150			34,380
0,260	0,070			34,310
1,130	0,870		 TDMR	33,440

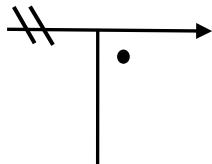
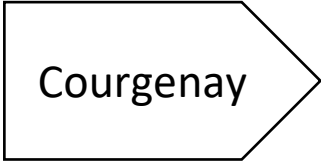
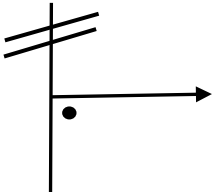
CH 1D Saignelégier				Secteur 1D
CH 2 Alle				
Distance (Km) 34,570		Temps (min) 45'	Vitesse (km/h) 46,093	
Kilométrage Total Partiel		DIRECTION	INFORMATION	Distance totale
1,460	0,330		<div style="border: 1px solid black; padding: 5px; display: inline-block;">Le Bémont</div> TDMR	33,110
4,810	3,350		<div style="border: 1px solid black; padding: 5px; display: inline-block;">Montfaucon</div> TDMR	29,760
10,560	5,750		<div style="border: 1px solid black; padding: 5px; display: inline-block;">St-Brais</div> TDMR	24,010
13,970	3,410		<div style="border: 1px solid black; padding: 5px; display: inline-block;">Delémont</div> TDMR	20,600
18,500	4,530		 <div style="border: 1px solid black; padding: 5px; display: inline-block;">Delémont</div> <div style="border: 1px solid black; padding: 5px; display: inline-block; opacity: 0.5;">Glovelier</div>	16,070

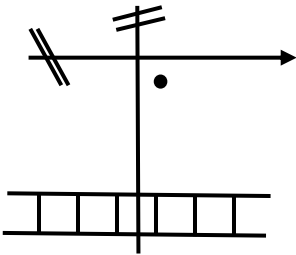
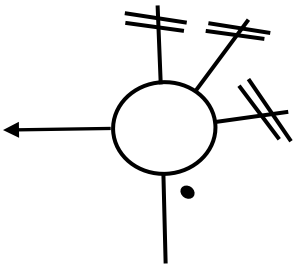
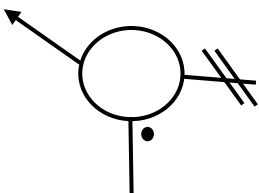
CH 1D Saignelégier				Secteur 1D
CH 2 Alle				
Distance (Km) 34,570		Temps (min) 45'	Vitesse (km/h) 46,093	
Kilométrage Total Partiel		DIRECTION	INFORMATION	Distance totale
20,550	2,050			14,020
		11		
20,710	0,160			13,860
		12		
20,810	0,100			13,760
		13		
24,510	3,700			10,060
		14		
29,310	4,800			5,260
		15		

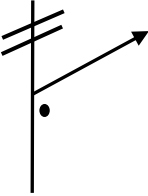
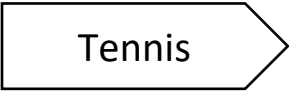
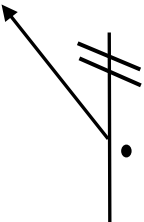
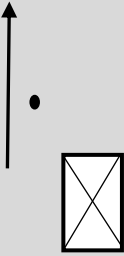
CH 1D Saignelégier			Secteur 1D	
CH 2 Alle				
Distance (Km) 34,570		Temps (min) 45'		Vitesse (km/h) 46,093
Kilométrage Total Partiel		DIRECTION	INFORMATION	Distance totale
29,840	0,530	 16		4,730
30,870	1,030	 17	 TDMR	3,700
33,110	2,240	 18		1,460
33,560	0,450	 19		1,010
33,710	0,150	 20		0,860

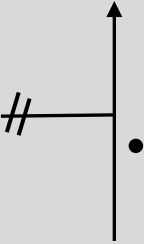
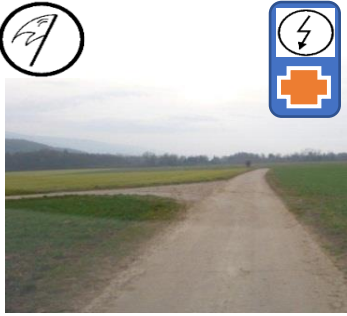
CH 1D Saignelégier			Secteur 1D	
CH 2 Alle				
Distance (Km) 34,570		Temps (min) 45'		Vitesse (km/h) 46,093
Kilométrage Total Partiel		DIRECTION	INFORMATION	Distance totale
34,070	0,360	 21		0,500
34,250	0,180	 22		0,320
34,570	0,320	 23		0,000
	0,230	 24		





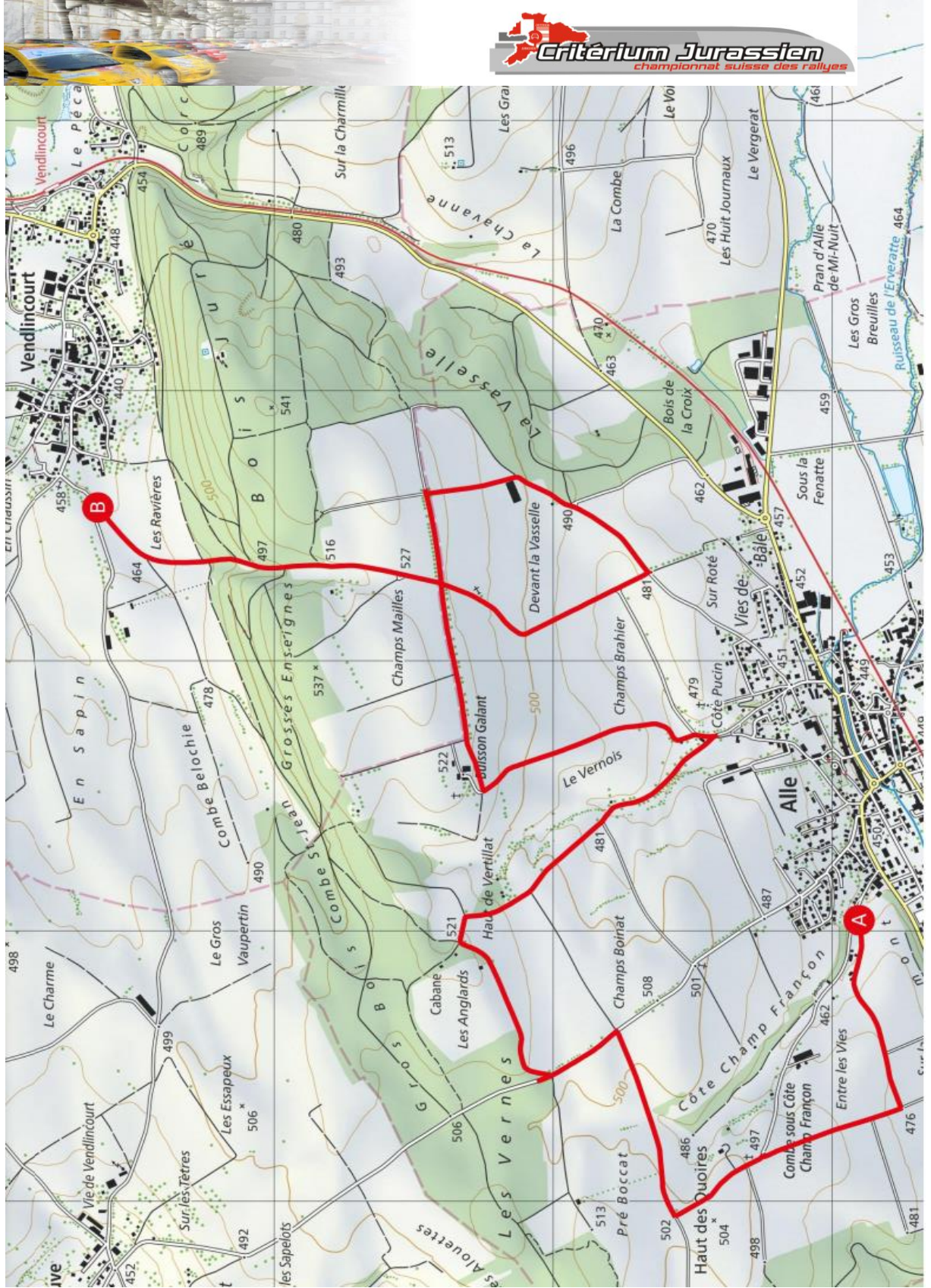



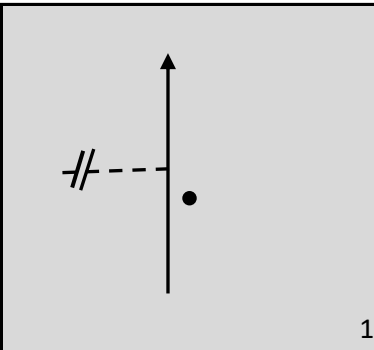
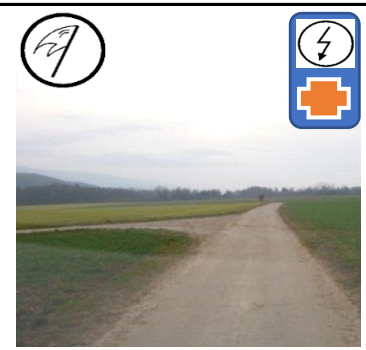
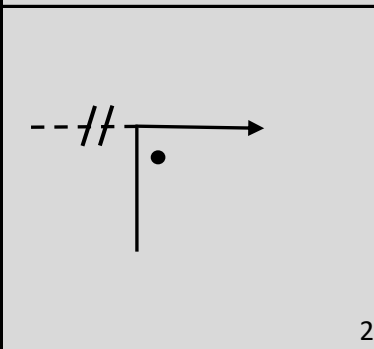
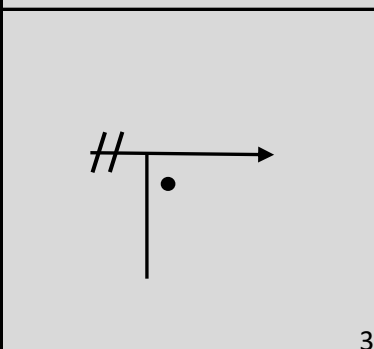
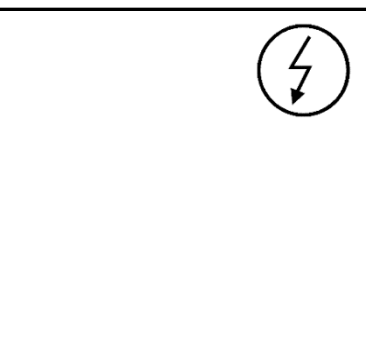
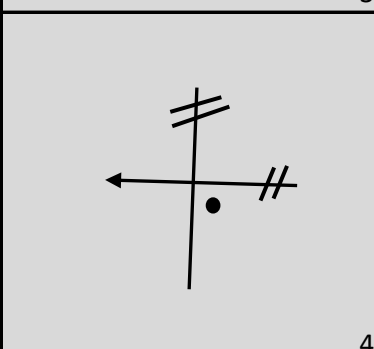
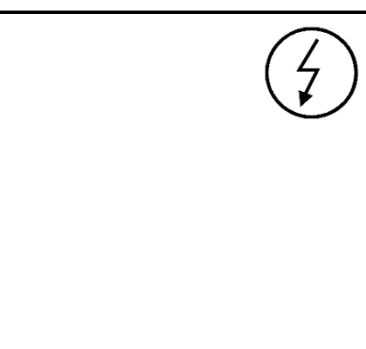
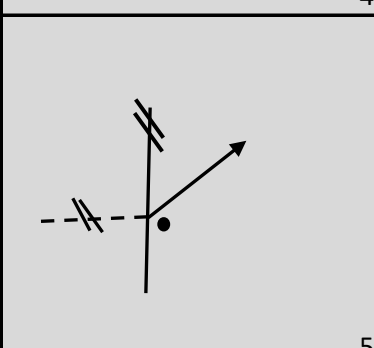
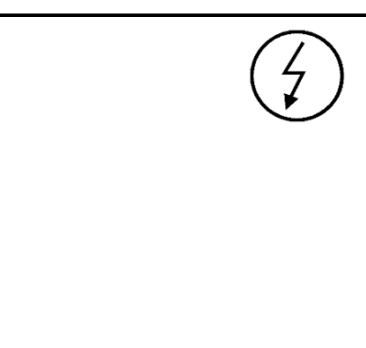

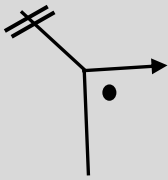

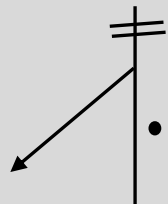

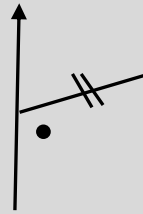
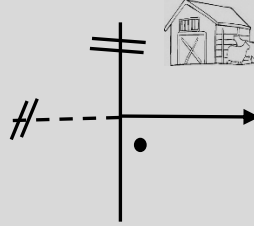

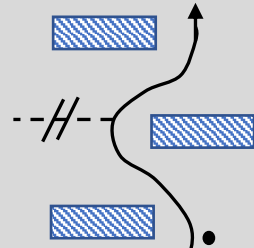

Alle - Vendlincourt

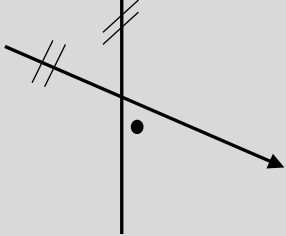

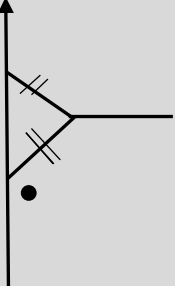
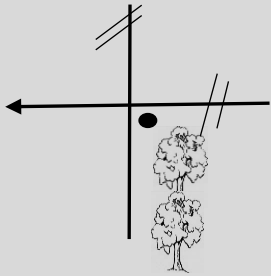

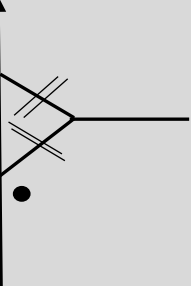

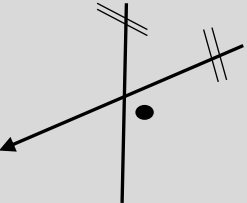

ES 2 Alle - Vendlincourt			Secteur 2
CH 3 St-Brais			
Distance (Km) 31,990	Temps (min) 40'	Vitesse (km/h) 47,98	
Kilométrage Total Partiel	DIRECTION	INFORMATION	Distance totale

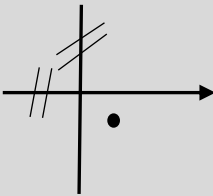
0,000	0,000			37,300
0,200	0,200		TDMR	37,100
1,120	0,920			36,180
1,840	0,720			35,460
2,130	0,290			35,170

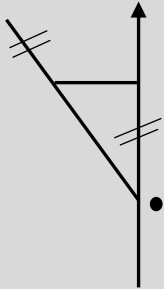
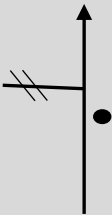

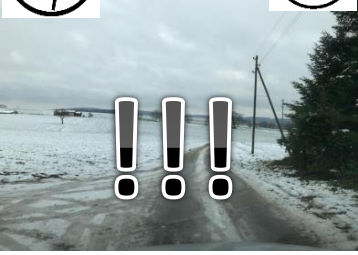
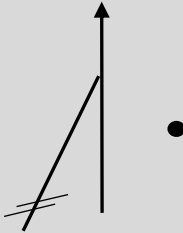



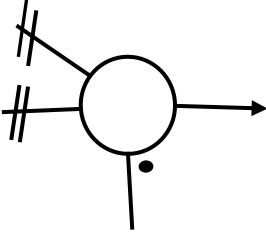
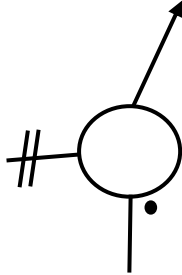
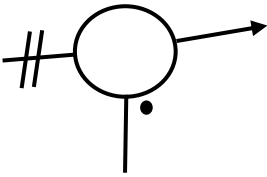
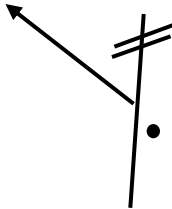
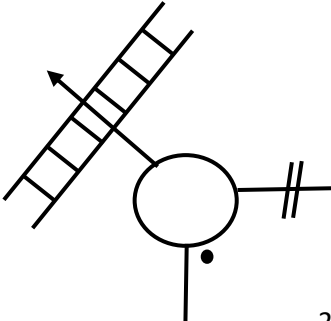
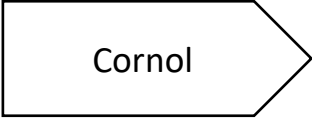

ES 2 Alle - Vendlincourt			Secteur 2	
CH 3 St-Brais				
Distance (Km) 31,990		Temps (min) 40'		Vitesse (km/h) 47,98
Kilométrage Total Partiel		DIRECTION	INFORMATION	Distance totale
2,860	0,730	 6		34,440
3,980	1,120	 7		33,320
4,040	0,060	 8		33,260
4,880	0,840	 9		32,420
5,320	0,440	 10		31,980

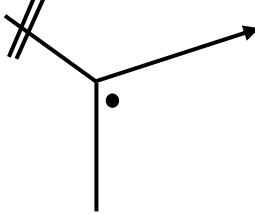

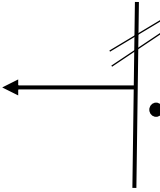

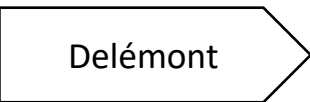
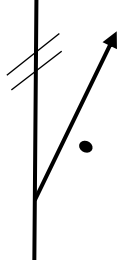
ES 2 Alle - Vendlincourt			Secteur 2	
CH 3 St-Brais				
Distance (Km) 31,990		Temps (min) 40'		Vitesse (km/h) 47,98
Kilométrage Total Partiel		DIRECTION	INFORMATION	Distance totale
5,640	0,320	 11		31,660
6,360	0,720	 12		30,940
6,490	0,130	 13		30,810
6,840	0,350	 14		30,460
7,420	0,580	 15		29,880

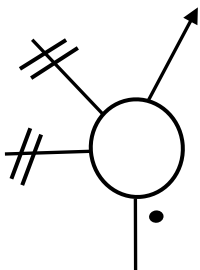
ES 2 Alle - Vendlincourt			Secteur 2	
CH 3 St-Brais				
Distance (Km) 31,990		Temps (min) 40'		Vitesse (km/h) 47,98
Kilométrage Total Partiel		DIRECTION	INFORMATION	Distance totale
7,750	0,330	 16		29,550
7,870	0,120	 17		29,430
8,700	0,830	 18	 	28,600
9,230	0,530	 19	 	28,070

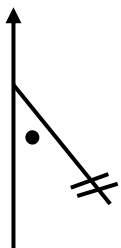
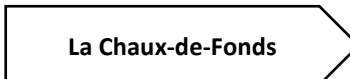
ES 2 Alle - Vendlincourt			Secteur 2
CH 3 St-Brais			
Distance (Km) 31,990	Temps (min) 40'	Vitesse (km/h) 47,98	
Kilométrage Total Partiel	DIRECTION	INFORMATION	Distance totale

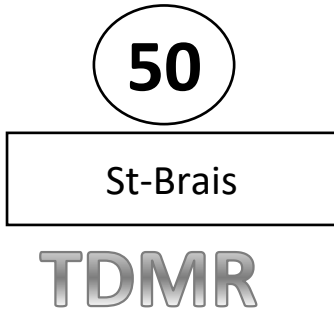
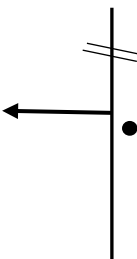
9,330	0,100	 20	TDMR	27,970
10,280	0,950	 21	TDMR	27,020
13,310	3,030	 22		23,990
14,020	0,710	 23		23,280
14,220	0,200	 24	 TDMR	23,080

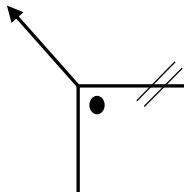
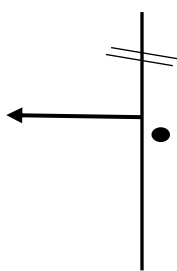
ES 2 Alle - Vendlincourt			Secteur 2	
CH 3 St-Brais				
Distance (Km) 31,990		Temps (min) 40'	Vitesse (km/h) 47,98	
Kilométrage Total Partiel		DIRECTION	INFORMATION	
Distance totale				
17,130	2,910	 25	 	20,170
18,440	1,310	 26	 	18,860
27,040	8,600	 27		10,260
27,330	0,290	 28	 TDMR	9,970
33,030	5,700	 29	 TDMR	4,270

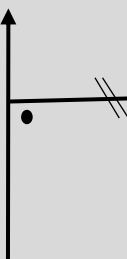
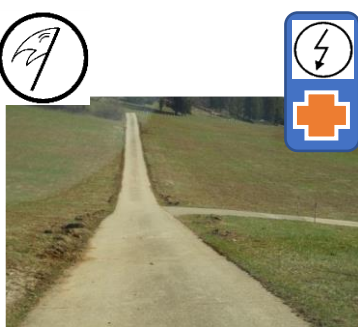



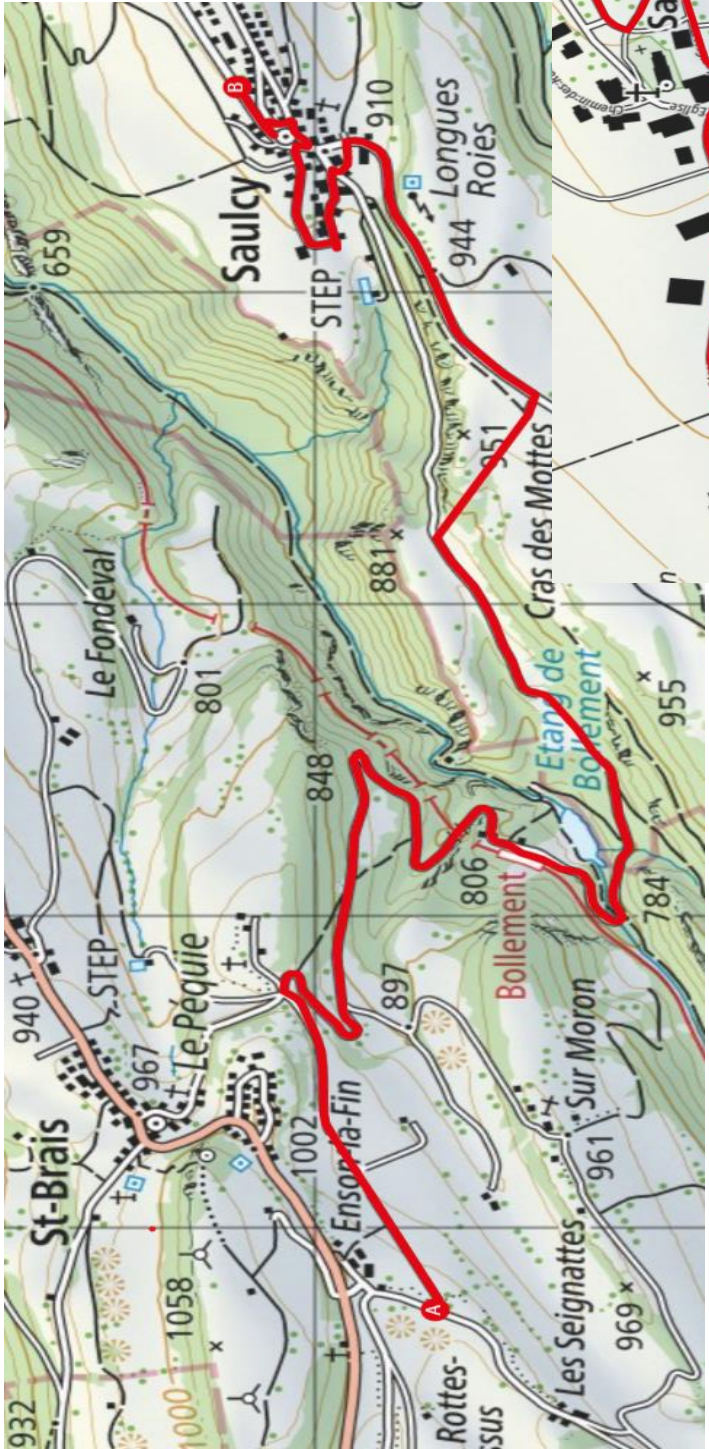

ES 2 Alle - Vendlincourt			Secteur 2	
CH 3 St-Brais				
Distance (Km) 31,990		Temps (min) 40'	Vitesse (km/h) 47,98	
Kilométrage Total Partiel		DIRECTION	INFORMATION	
			Distance totale	
35,230	2,200			2,070
37,030	1,800			0,270
37,110	0,080			0,190
37,300	0,190			0,000
	0,490			



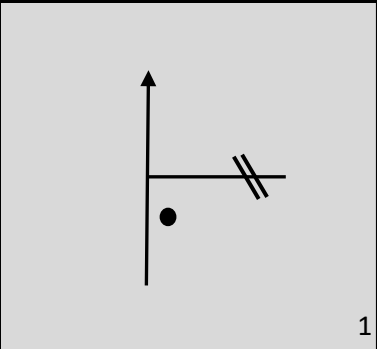

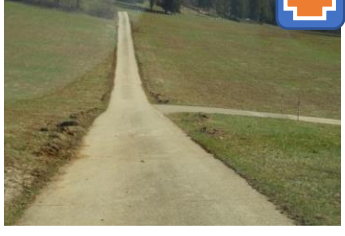
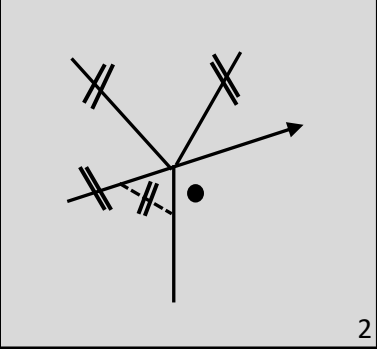

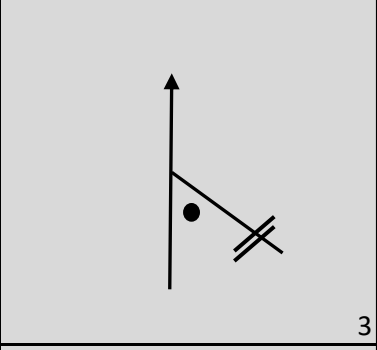
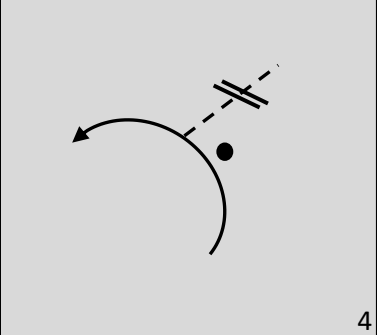

St-Brais - Saulcy

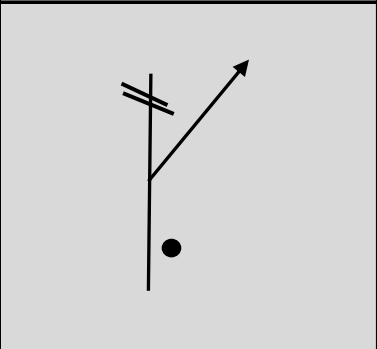
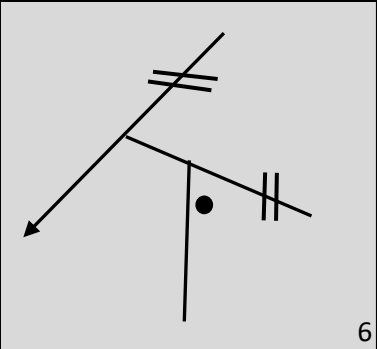

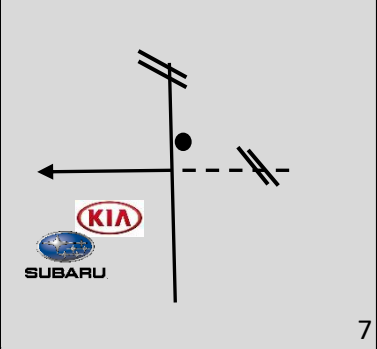

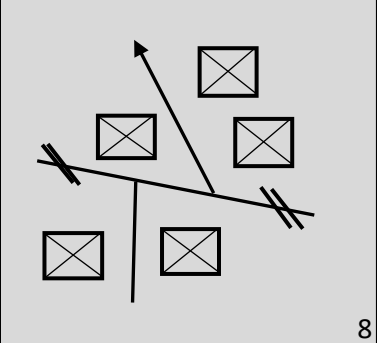



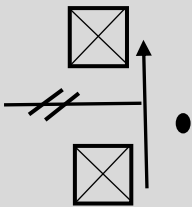

ES 3 St-Brais - Saulcy			Secteur 3
CH 4 Le Pré-Petitjean			
Distance (Km) 28,500	Temps (min) 40'	Vitesse (km/h) 42,07	
Kilométrage Total Partiel		DIRECTION	INFORMATION
			Distance totale

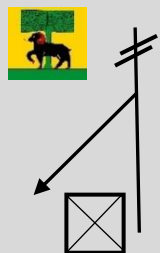

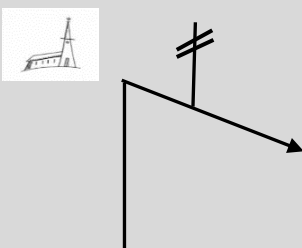

0,000	0,000	 1	 	28,500
0,620	0,620	 2		27,880
1,060	0,440	 3	TDMR	27,440
3,150	2,090	 4	 TDMR	25,350







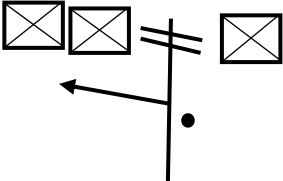

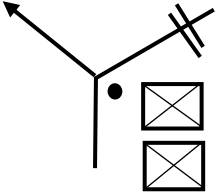
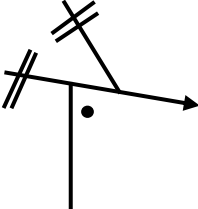
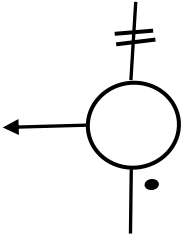
ES 3 St-Brais - Saulcy			Secteur 3	
CH 4 Le Pré-Petitjean				
Distance (Km) 28,500	Temps (min) 40'	Vitesse (km/h) 42,07		
Kilométrage Total Partiel		DIRECTION	INFORMATION	Distance totale
4,530	1,380			23,970
5,170	0,640			23,330
6,170	1,000		 	22,330
6,260	0,090			22,240



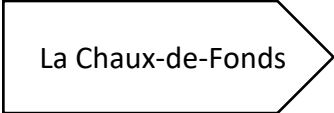
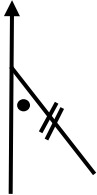
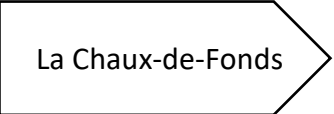

ES 3 St-Brais - Saulcy				Secteur 3
CH 4 Le Pré-Petitjean				
Distance (Km) 28,500		Temps (min) 40'	Vitesse (km/h) 42,07	
Kilométrage Total Partiel		DIRECTION	INFORMATION	Distance totale
6,480	0,220	 9		22,020
6,810	0,330	 10		21,690
6,870	0,060	 11		21,630
6,890	0,020	 12		21,610

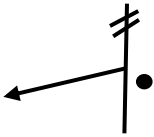
ES 3 St-Brais - Saulcy			Secteur 3	
CH 4 Le Pré-Petitjean				
Distance (Km) 28,500	Temps (min) 40'	Vitesse (km/h) 42,07		
Kilométrage Total Partiel		DIRECTION	INFORMATION	Distance totale
6,980	0,090	 13	 	21,520
7,020	0,040	 14	 	21,480
7,070	0,050	 15		21,430
7,130	0,060	 16	 	21,370

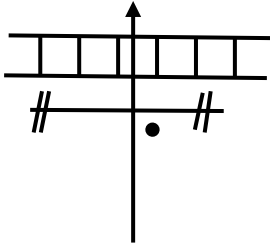
ES 3 St-Brais - Saulcy			Secteur 3
CH 4 Le Pré-Petitjean			
Distance (Km) 28,500	Temps (min) 40'	Vitesse (km/h) 42,07	
Kilométrage Total Partiel	DIRECTION	INFORMATION	Distance totale

7,280	0,150		  <p>TDMR</p>	21,220
8,620	1,340			19,880
8,670	0,050			19,830
9,270	0,600			19,230
13,410	4,140		TDMR	15,090

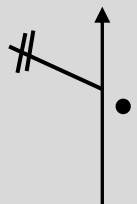
ES 3 St-Brais - Saulcy			Secteur 3	
CH 4 Le Pré-Petitjean				
Distance (Km) 28,500		Temps (min) 40'	Vitesse (km/h) 42,07	
Kilométrage Total Partiel		DIRECTION	INFORMATION	
			Distance totale	
14,040	0,630		 	14,460
		22		
18,640	4,600		 TDMR	9,860
		23		
26,640	8,000		 	1,860
		24		
27,140	0,500		 TDMR	1,360
		25		
28,200	1,060		TDMR	0,300
		26		





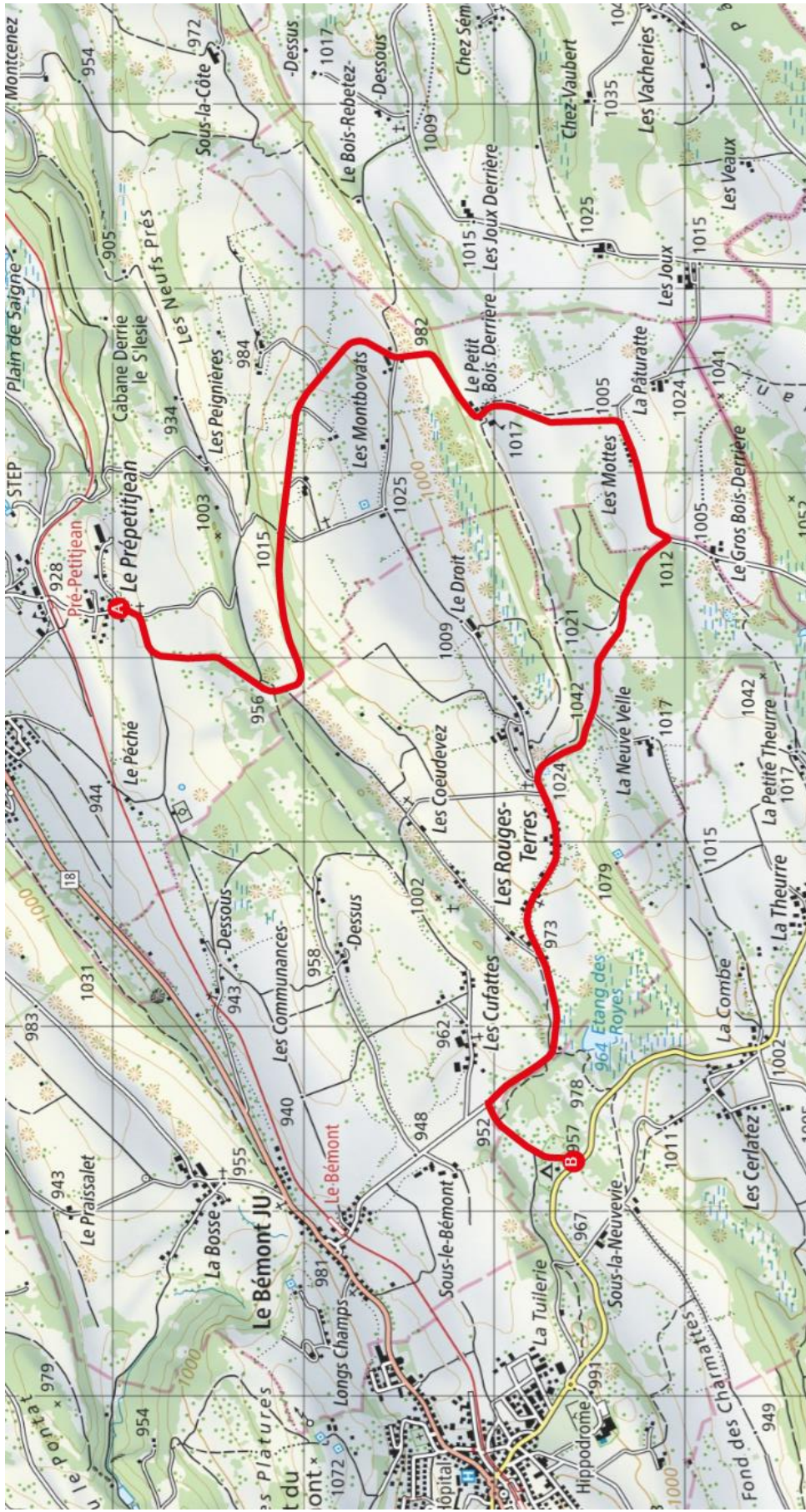

ES 3 St-Brais - Saulcy			Secteur 3
CH 4 Le Pré-Petitjean			
Distance (Km) 28,500		Temps (min) 40'	Vitesse (km/h) 42,07
Kilométrage Total Partiel		DIRECTION	INFORMATION
28,500	0,300		
	0,250		



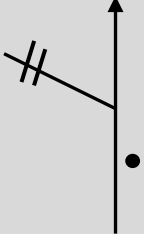

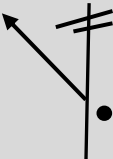
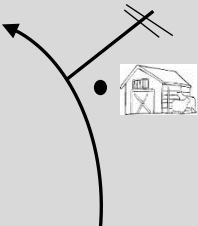
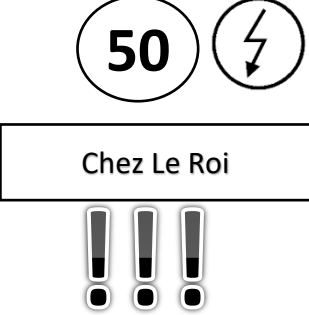

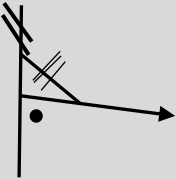

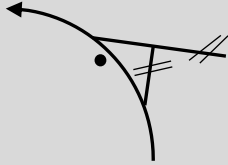
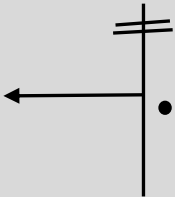

Le Prépetitjean - Le Bémont



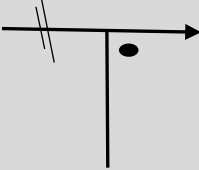

ES 4 Le Pré-Petitjean - Le Bémont			Secteur 4
CH 4 A Saignelégier			
Distance (Km) 11,550	Temps (min) 15'	Vitesse (km/h) 46,20	
Kilométrage Total Partiel	DIRECTION	INFORMATION	Distance totale

0,000	0,000	 1		11,550
0,210	0,210	 2	TDMR	11,340
3,260	3,050	 3		8,290
4,660	1,400	 4		6,890
5,350	0,690	 5	 TDMR	6,200

ES 4 Le Pré-Petitjean - Le Bémont			Secteur 4
CH 4 A Saignelégier			
Distance (Km) 11,550		Temps (min) 15'	Vitesse (km/h) 46,20
Kilométrage Total Partiel		DIRECTION	INFORMATION
			Distance totale
6,910	1,560	 6	TDMR
8,910	2,000	 7	
8,960	0,050	 8	  
9,460	0,500	 9	  

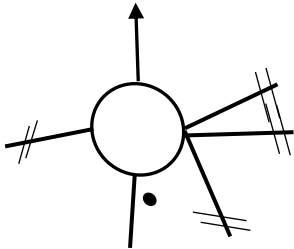
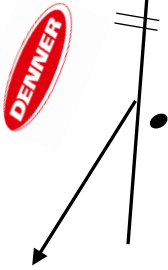
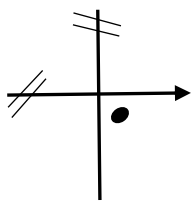





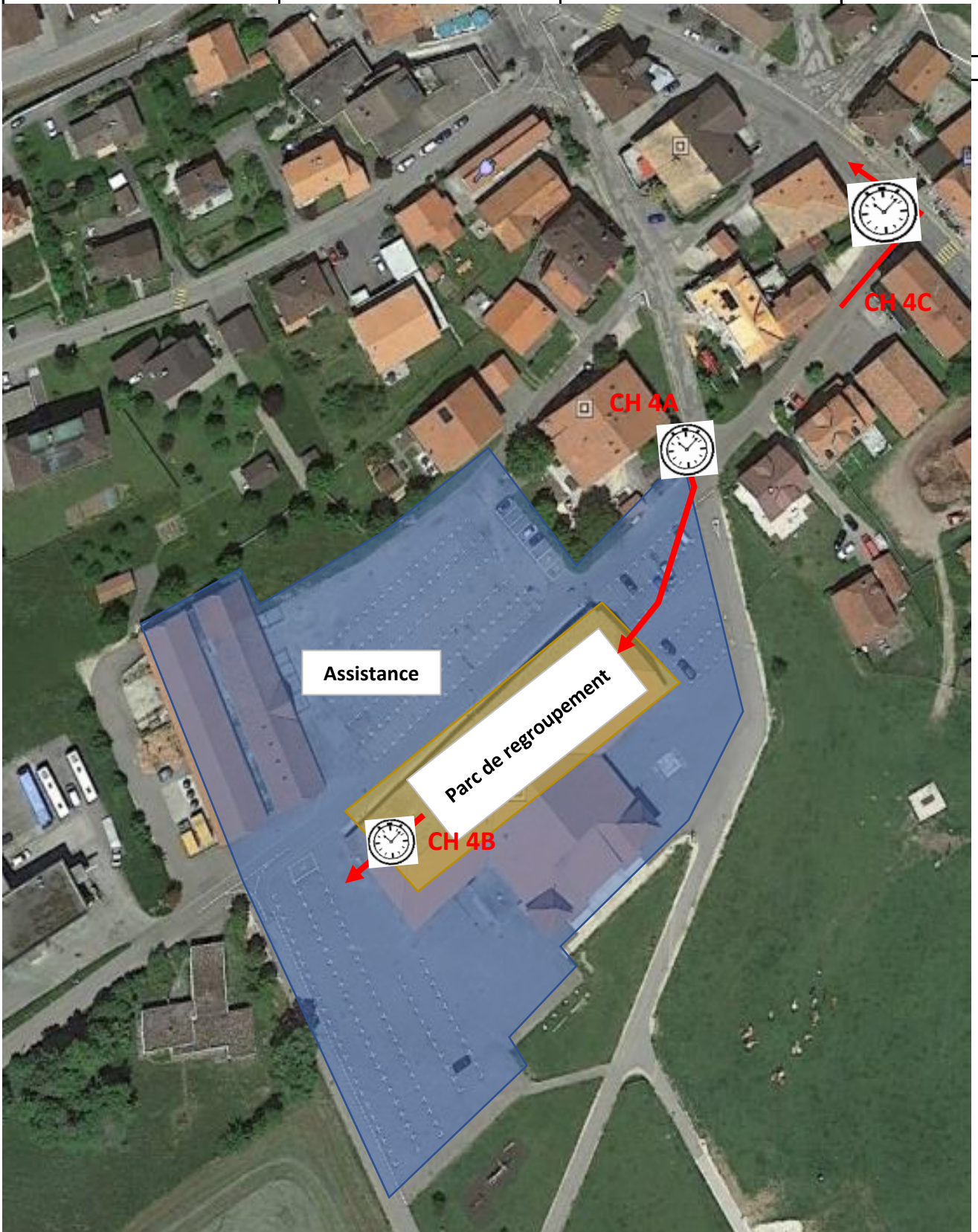

ES 4 Le Pré-Petitjean - Le Bémont			Secteur 4
CH 4 A Saignelégier			
Distance (Km) 11,550	Temps (min) 15'	Vitesse (km/h) 46,20	
Kilométrage Total Partiel	DIRECTION	INFORMATION	Distance totale



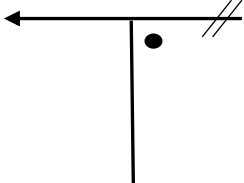

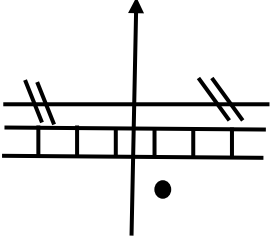
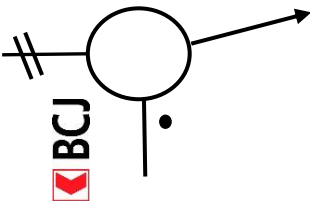
10,810	1,350	 10	TDMR	0,740
11,410	0,600	 11		0,140
11,550	0,140	 12		0,000

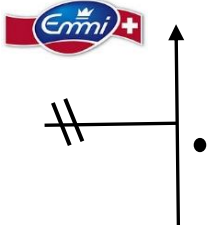



CH 4 A Entrée regroupement Saignelégier		Secteur 4A/B
CH 4 B Sortie regroupement entrée assistance Saignelégier		
CH 4 C Sortie assistance Saignelégier		
Regroupement (min) 40'	Assistance (min) 30'	

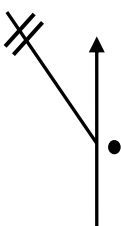
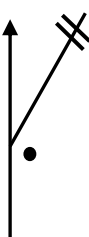



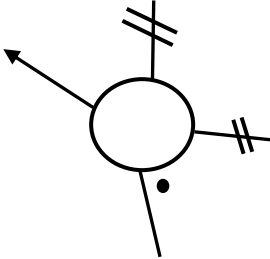
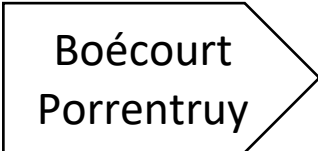
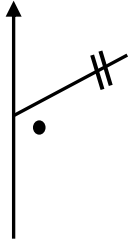
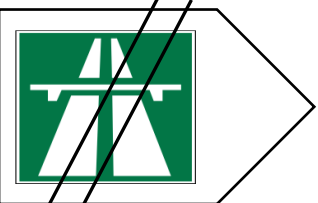

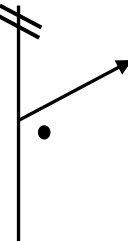
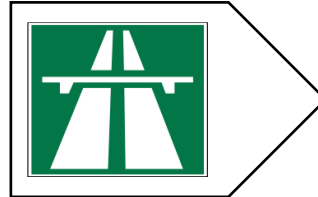
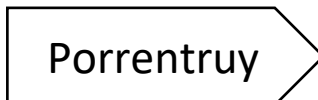
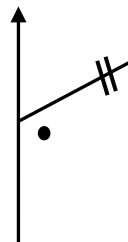
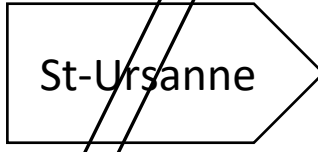
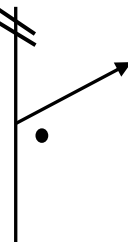

CH 4C Saignelégier			Secteur 4C
CH 5 Alle			
Distance (Km) 34,570	Temps (min) 45'	Vitesse (km/h) 46,093	
Kilométrage Total Partiel	DIRECTION	INFORMATION	Distance totale

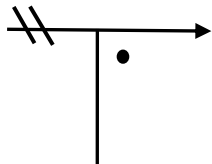
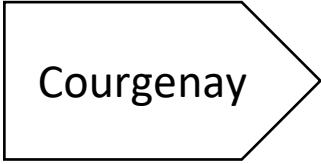
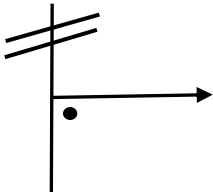
0,000	0,000			34,570
0,040	0,040			34,530
0,190	0,150			34,380
0,260	0,070			34,310
1,130	0,870		 TDMR	33,440

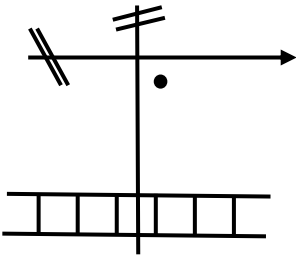
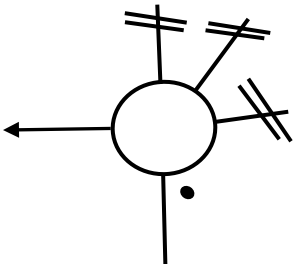
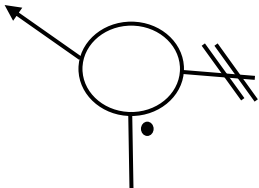
CH 4C Saignelégier				Secteur 4C
CH 5 Alle				
Distance (Km) 34,570		Temps (min) 45'	Vitesse (km/h) 46,093	
Kilométrage Total Partiel		DIRECTION	INFORMATION	Distance totale
1,460	0,330		<div style="border: 1px solid black; padding: 5px; display: inline-block;">Le Bémont</div> TDMR	33,110
4,810	3,350		<div style="border: 1px solid black; padding: 5px; display: inline-block;">Montfaucon</div> TDMR	29,760
10,560	5,750		<div style="border: 1px solid black; padding: 5px; display: inline-block;">St-Brais</div> TDMR	24,010
13,970	3,410		<div style="border: 1px solid black; padding: 5px; display: inline-block;">Delémont</div> TDMR	20,600
18,500	4,530		 <div style="border: 1px solid black; padding: 5px; display: inline-block;">Delémont</div> <div style="border: 1px solid black; padding: 5px; display: inline-block; opacity: 0.5;">Glövelier</div>	16,070

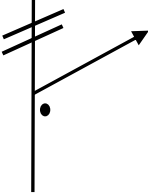
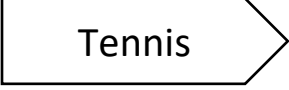
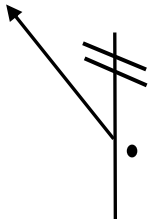
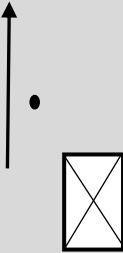
CH 4C Saignelégier			Secteur 4C	
CH 5 Alle				
Distance (Km) 34,570	Temps (min) 45'	Vitesse (km/h) 46,093		
Kilométrage Total Partiel		DIRECTION	INFORMATION	Distance totale
20,550	2,050	 11	 Boécourt Porrentruy	14,020
20,710	0,160	 12	  Delémont	13,860
20,810	0,100	 13	  Porrentruy	13,760
24,510	3,700	 14	 St-Ursanne	10,060
29,310	4,800	 15	 Courgenay	5,260

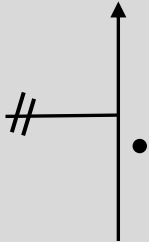
CH 4C Saignelégier			Secteur 4C	
CH 5 Alle				
Distance (Km) 34,570		Temps (min) 45'		Vitesse (km/h) 46,093
Kilométrage Total Partiel		DIRECTION	INFORMATION	Distance totale
29,840	0,530	 16		4,730
30,870	1,030	 17	 TDMR	3,700
33,110	2,240	 18		1,460
33,560	0,450	 19		1,010
33,710	0,150	 20		0,860





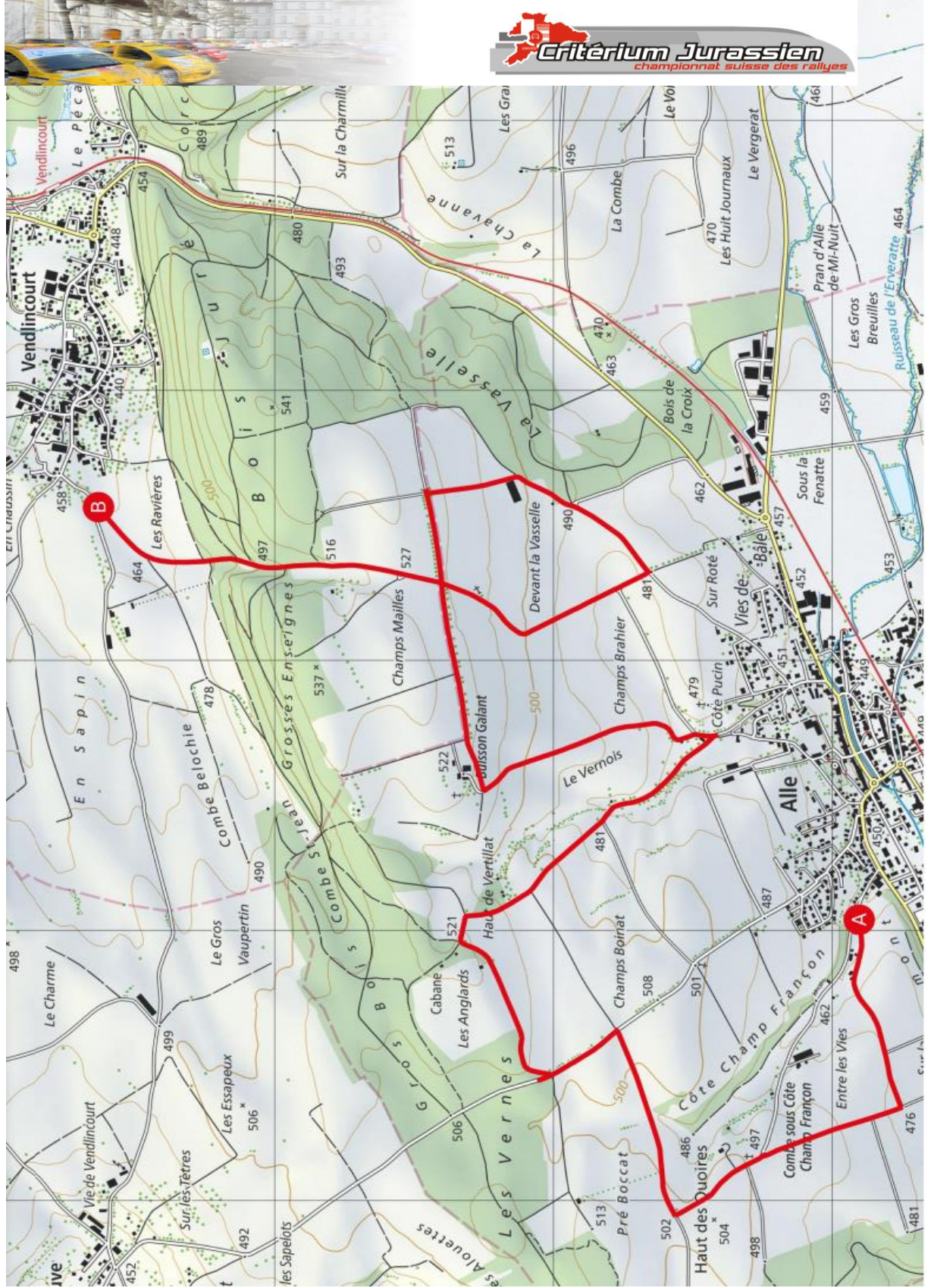

CH 4C Saignelégier			Secteur 4C	
CH 5 Alle				
Distance (Km) 34,570		Temps (min) 45'		Vitesse (km/h) 46,093
Kilométrage Total Partiel		DIRECTION	INFORMATION	Distance totale
34,070	0,360	 21		0,500
34,250	0,180	 22		0,320
34,570	0,320	 23		0,000
	0,230	 24		



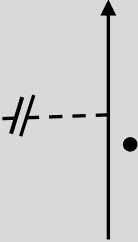
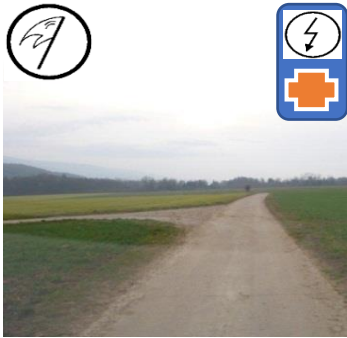
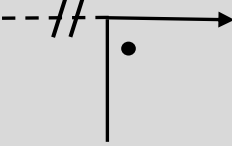
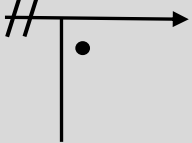

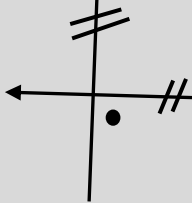

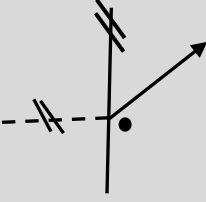



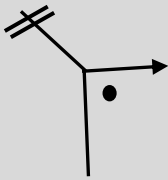

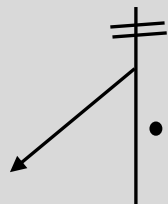

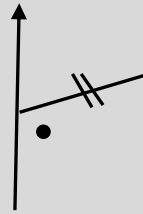
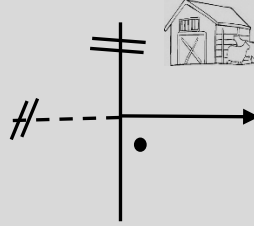

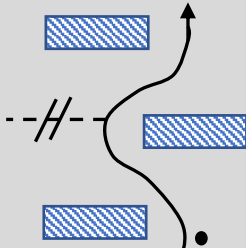

Alle - Vendlincourt

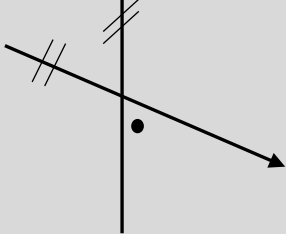

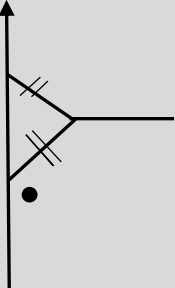
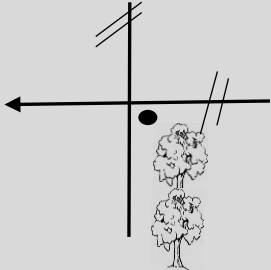

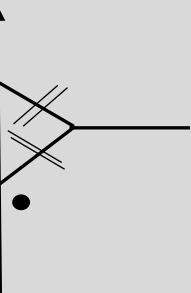

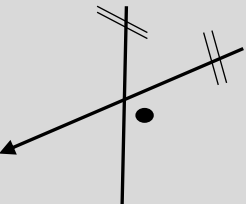

ES 5 Alle - Vendlincourt			Secteur 5
CH 6 Les Rangiers			
Distance (Km) 23,200	Temps (min) 30'	Vitesse (km/h) 46,40	
Kilométrage Total Partiel	DIRECTION	INFORMATION	Distance totale

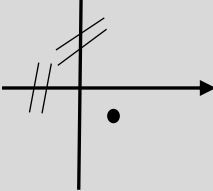
0,000	0,000			23,200
0,200	0,200		TDMR	23,000
1,120	0,920			22,080
1,840	0,720			21,360
2,130	0,290			21,070

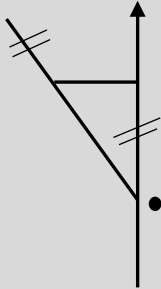
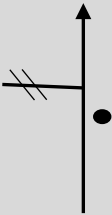

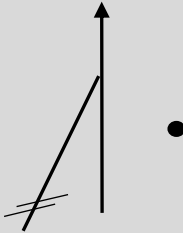





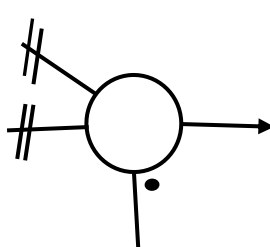
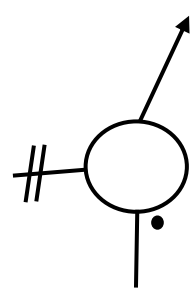
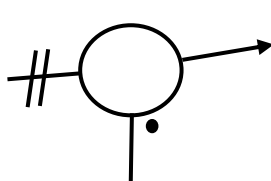
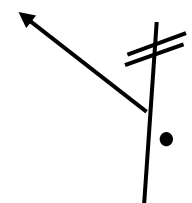
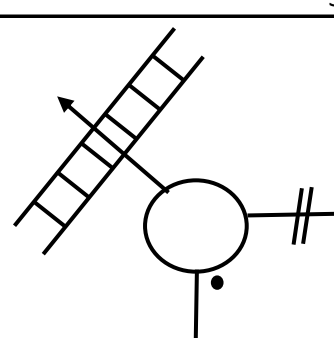
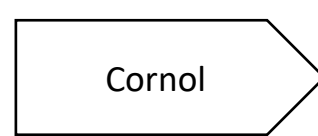

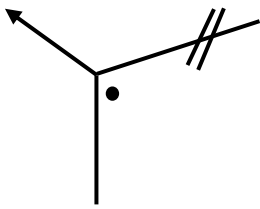

ES 5 Alle - Vendlincourt			Secteur 5	
CH 6 Les Rangiers				
Distance (Km) 23,200		Temps (min) 30'		Vitesse (km/h) 46,40
Kilométrage Total Partiel		DIRECTION	INFORMATION	Distance totale
2,860	0,730	 6		20,340
3,980	1,120	 7		19,220
4,040	0,060	 8		19,160
4,880	0,840	 9		18,320
5,320	0,440	 10		17,880

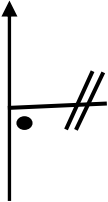
ES 5 Alle - Vendlincourt			Secteur 5
CH 6 Les Rangiers			
Distance (Km) 23,200	Temps (min) 30'	Vitesse (km/h) 46,40	
Kilométrage Total Partiel		DIRECTION	INFORMATION
			Distance totale
5,640	0,320	 11	 17,560
6,360	0,720	 12	16,840
6,490	0,130	 13	 16,710
6,840	0,350	 14	 16,360
7,420	0,580	 15	 15,780

ES 5 Alle - Vendlincourt			Secteur 5	
CH 6 Les Rangiers				
Distance (Km) 23,200	Temps (min) 30'	Vitesse (km/h) 46,40		
Kilométrage Total Partiel		DIRECTION	INFORMATION	Distance totale
7,750	0,330	 16		15,450
7,870	0,120	 17		15,330
8,700	0,830	 18	 	14,500
9,230	0,530	 19	 	13,970

ES 5 Alle - Vendlincourt			Secteur 5
CH 6 Les Rangiers			
Distance (Km) 23,200	Temps (min) 30'	Vitesse (km/h) 46,40	
Kilométrage Total Partiel	DIRECTION	INFORMATION	Distance totale

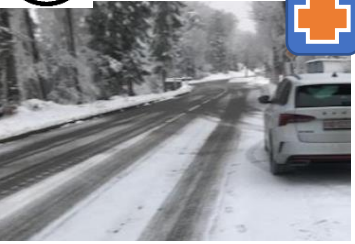
9,330	0,100	 20	TDMR	13,870
10,280	0,950	 31	TDMR	12,920
13,310	3,030	 32		9,890
14,020	0,710	 33		9,180
14,220	0,200	 34	 TDMR	8,980





ES 5 Alle - Vendlincourt			Secteur 5	
CH 6 Les Rangiers				
Distance (Km) 23,200		Temps (min) 30'	Vitesse (km/h) 46,40	
Kilométrage Total Partiel		DIRECTION	INFORMATION	
			Distance totale	
17,130	2,910	 35	  TDMR	6,070
20,380	3,250	 36		2,820
23,120	2,740	 37		0,080
23,200	0,080	 38	 	0,000
	0,200	 39	   	

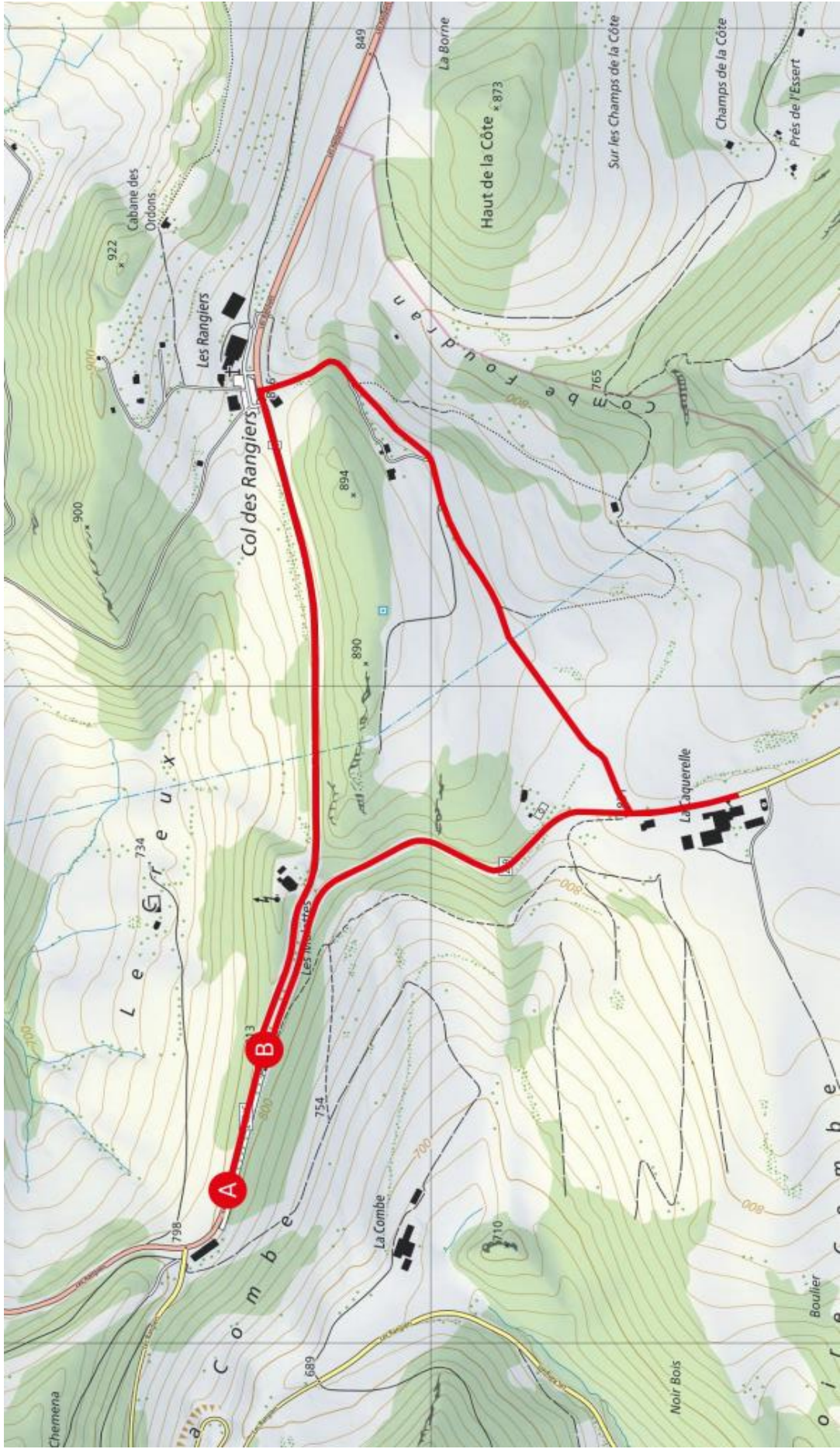



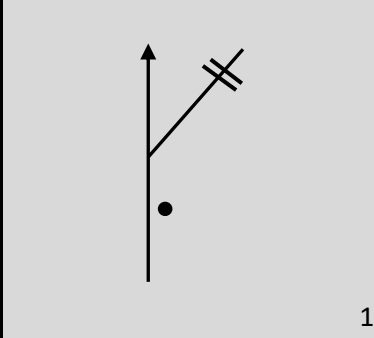

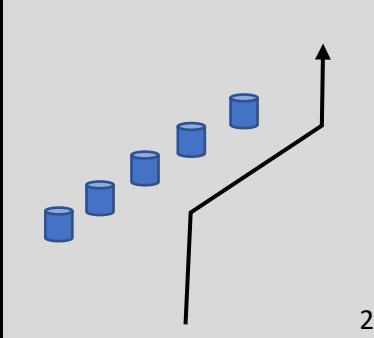
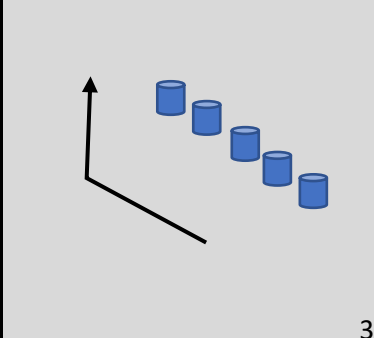
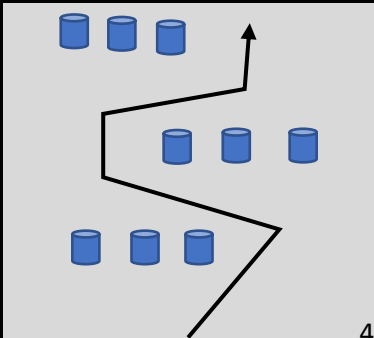
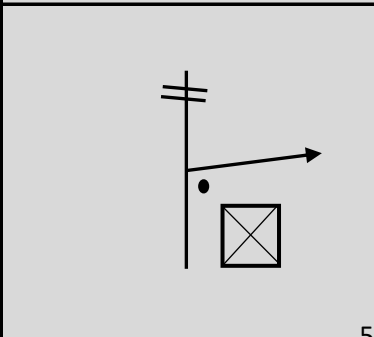

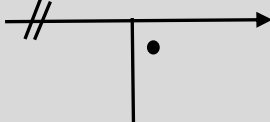
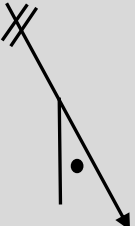

Super ES Les Rangiers

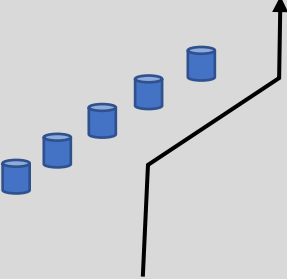

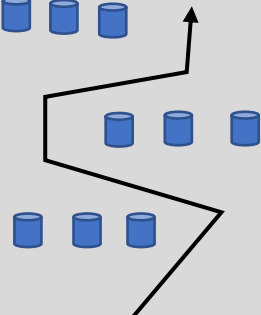

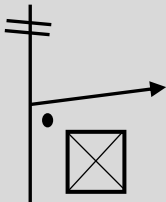
ES 6 Les Rangiers			Secteur 6
CH 7 Le Pré-Petitjean			
Distance (Km) 24,200	Temps (min) 35'	Vitesse (km/h) 43,35	
Kilométrage Total Partiel	DIRECTION	INFORMATION	Distance totale

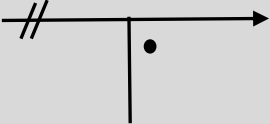

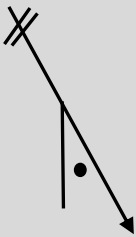
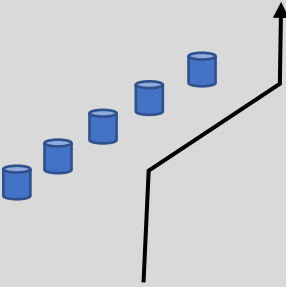
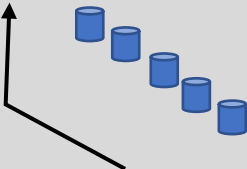
0,000	0,000	 1		24,200
		 2		
		 3		
		 4		
1,090	1,090	 5		23,110

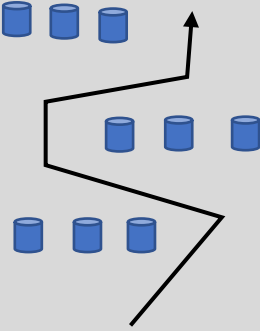
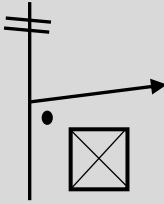
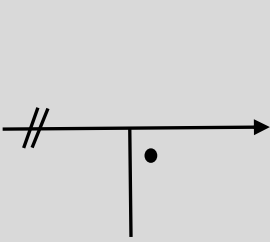
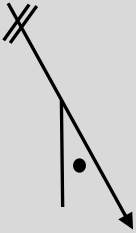
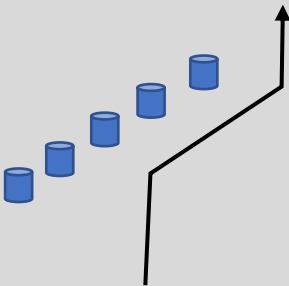
ES 6 Les Rangiers			Secteur 6	
CH 7 Le Pré-Petitjean				
Distance (Km) 24,200		Temps (min) 35'		Vitesse (km/h) 43,35
Kilométrage Total Partiel		DIRECTION	INFORMATION	Distance totale
2,030	0,940			22,170
2,800	0,770			21,400
				
				
				

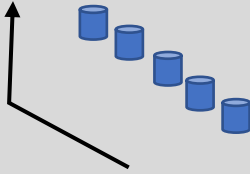
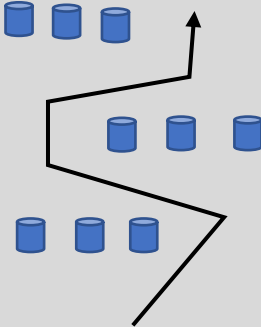
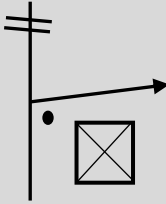
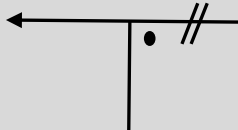

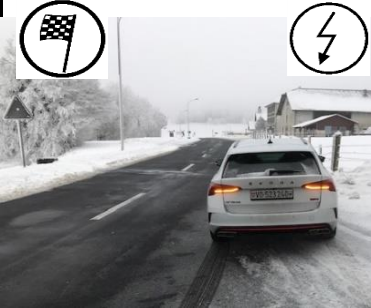
ES 6 Les Rangiers			Secteur 6	
CH 7 Le Pré-Petitjean				
Distance (Km) 24,200		Temps (min) 35'		Vitesse (km/h) 43,35
Kilométrage Total Partiel		DIRECTION	INFORMATION	Distance totale
3,820	1,020	 11		20,380
4,760	0,940	 12		19,440
5,530	0,770	 13		18,670
		 14		
		 15		

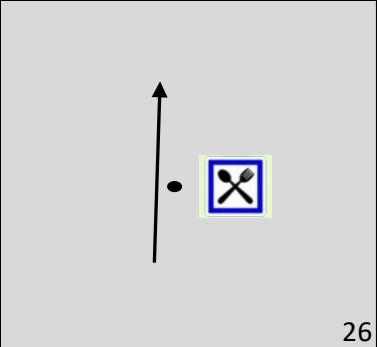

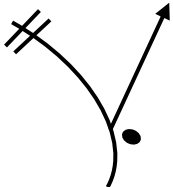
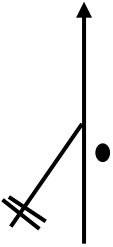

ES 6 Les Rangiers			Secteur 6
CH 7 Le Pré-Petitjean			
Distance (Km) 24,200	Temps (min) 35'	Vitesse (km/h) 43,35	
Kilométrage Total Partiel		DIRECTION	INFORMATION
			Distance totale
		 16	
6,550	1,020	 17	17,650
7,490	0,940	 18	16,710
8,260	0,770	 19	15,940
		 20	

ES 6 Les Rangiers			Secteur 6	
CH 7 Le Pré-Petitjean				
Distance (Km) 24,200	Temps (min) 35'	Vitesse (km/h) 43,35		
Kilométrage Total Partiel		DIRECTION	INFORMATION	Distance totale
		 <p style="text-align: right;">21</p>		
		 <p style="text-align: right;">22</p>		
9,280	1,020	 <p style="text-align: right;">23</p>		14,920
10,220	0,940	 <p style="text-align: right;">24</p>		13,980
10,270	0,050	 <p style="text-align: right;">25</p>		13,930

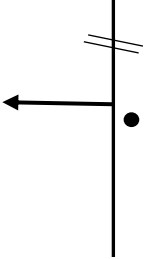
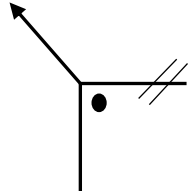
ES 6 Les Rangiers			Secteur 6
CH 7 Le Pré-Petitjean			
Distance (Km) 24,200		Temps (min) 35'	Vitesse (km/h) 43,35
Kilométrage Total Partiel		DIRECTION	INFORMATION
10,470	0,200	 <p style="text-align: right;">26</p>	
			Distance totale 13,730

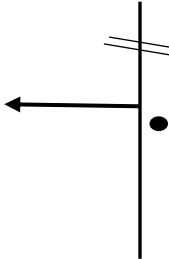
ES 6 Les Rangiers			Secteur 6
CH 7 Le Pré-Petitjean			
Distance (Km) 25,290	Temps (min) 35'	Vitesse (km/h) 43,35	
Kilométrage Total Partiel	DIRECTION	INFORMATION	Distance totale

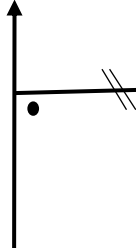
10,620	0,150	 27	La Chaux-de-Fonds TDMR	13,580
20,460	9,840	 28	TDMR	3,740
22,660	2,200	 29	50 St-Brais TDMR	1,540
23,930	1,270	 30	Enson La Fin	0,270
24,010	0,080	 31		0,190

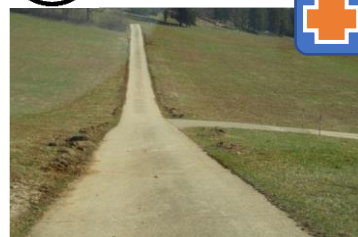





ES 6 Les Rangiers			Secteur 6	
CH 7 Le Pré-Petitjean				
Distance (Km) 25,290	Temps (min) 35'	Vitesse (km/h) 43,35		
Kilométrage Total Partiel		DIRECTION	INFORMATION	Distance totale
24,200	0,190	 32	 	0,000
	0,490	 33	  	



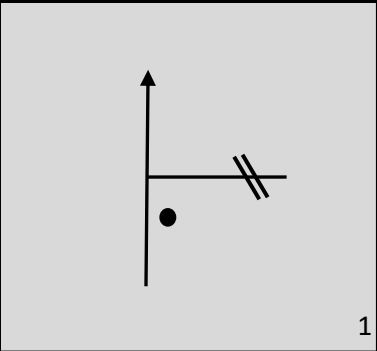

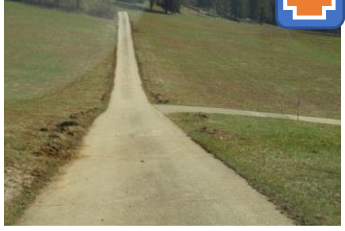
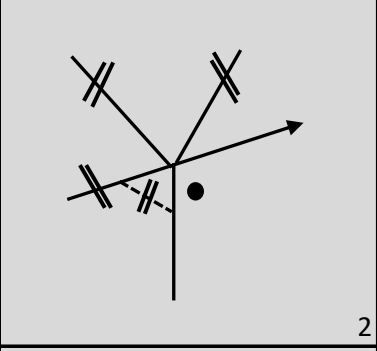

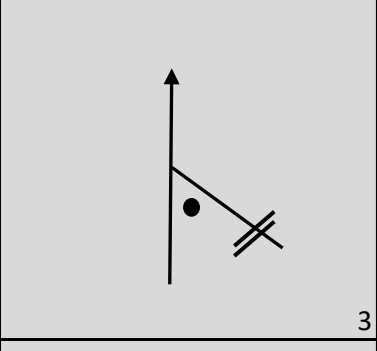
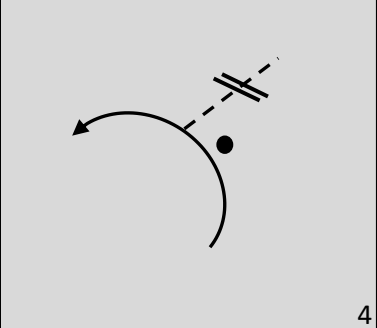



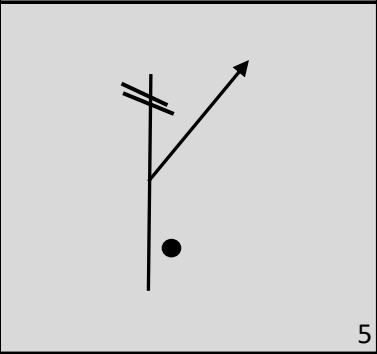
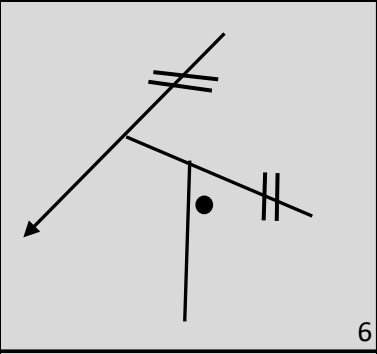

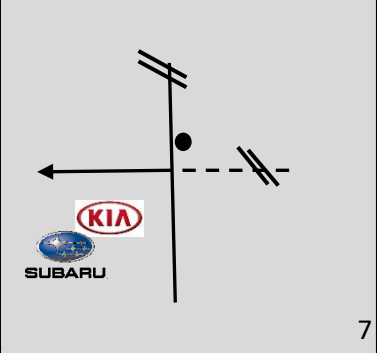

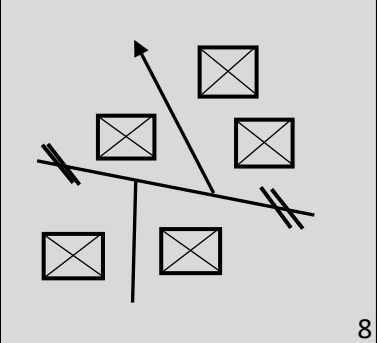

St-Brais - Saulcy

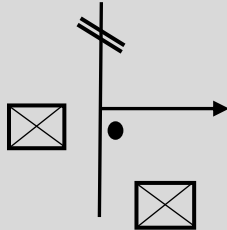

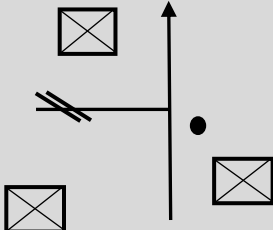

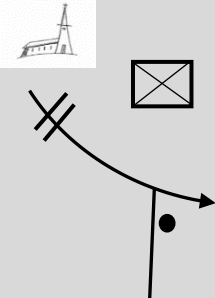

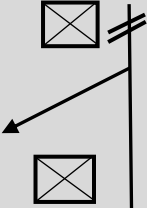

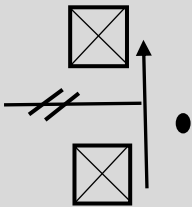

ES 7 St-Brais - Saulcy			Secteur 7
CH 8 Le Pré-Petitjean			
Distance (Km) 28,900	Temps (min) 40'	Vitesse (km/h) 42,07	
Kilométrage Total Partiel		DIRECTION	INFORMATION
			Distance totale

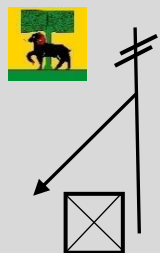

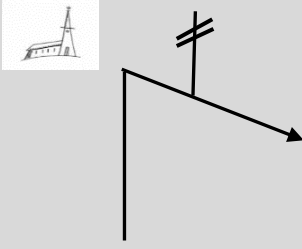

0,000	0,000	 1	 	28,500
0,620	0,620	 2		27,880
1,060	0,440	 3	TDMR	27,440
3,150	2,090	 4	 TDMR	25,350







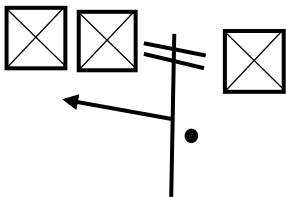

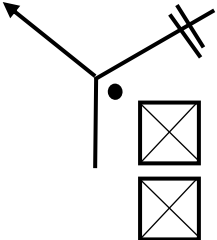
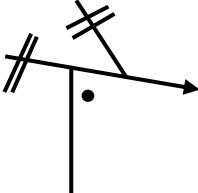
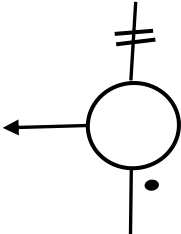
ES 7 St-Brais - Saulcy			Secteur 7	
CH 8 Le Pré-Petitjean				
Distance (Km) 28,900	Temps (min) 40'	Vitesse (km/h) 42,07		
Kilométrage Total Partiel		DIRECTION	INFORMATION	Distance totale
4,530	1,380	 5		23,970
5,170	0,640	 6		23,330
6,170	1,000	 7	 	22,330
6,260	0,090	 8		22,240



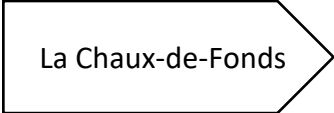
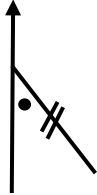
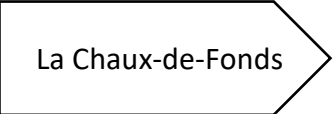

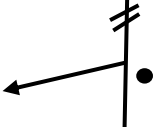

ES 7 St-Brais - Saulcy			Secteur 7	
CH 8 Le Pré-Petitjean				
Distance (Km) 28,900	Temps (min) 40'	Vitesse (km/h) 42,07		
Kilométrage Total Partiel		DIRECTION	INFORMATION	Distance totale
6,480	0,220	 9	 	22,020
6,810	0,330	 10	 	21,690
6,870	0,060	 11	 	21,630
6,890	0,020	 12	 	21,610

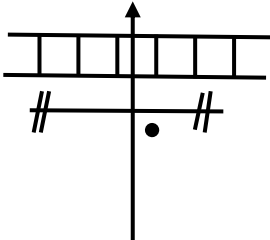
ES 7 St-Brais - Saulcy			Secteur 7	
CH 8 Le Pré-Petitjean				
Distance (Km) 28,900	Temps (min) 40'	Vitesse (km/h) 42,07		
Kilométrage Total Partiel		DIRECTION	INFORMATION	Distance totale
6,980	0,090	 13	 	21,520
7,020	0,040	 14		21,480
7,070	0,050	 15		21,430
7,130	0,060	 16	 	21,370

ES 7 St-Brais - Saulcy			Secteur 7
CH 8 Le Pré-Petitjean			
Distance (Km) 28,500	Temps (min) 40'	Vitesse (km/h) 42,07	
Kilométrage Total Partiel	DIRECTION	INFORMATION	Distance totale

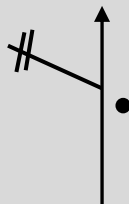
7,280	0,150		  <p>TDMR</p>	21,220
8,620	1,340			19,880
8,670	0,050			19,830
9,270	0,600			19,230
13,410	4,140		<p>TDMR</p>	15,090

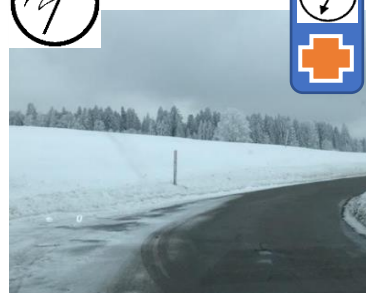
ES 7 St-Brais - Saulcy			Secteur 7	
CH 8 Le Pré-Petitjean				
Distance (Km) 28,500	Temps (min) 40'	Vitesse (km/h) 42,07		
Kilométrage Total Partiel		DIRECTION	INFORMATION	Distance totale
14,040	0,630	 22	 	14,460
18,640	4,600	 23	 TDMR	9,860
26,640	8,000	 24	 	1,860
27,140	0,500	 25	 TDMR	1,360
28,200	1,060	 26	TDMR	0,300





ES 7 St-Brais - Saulcy			Secteur 7
CH 8 Le Pré-Petitjean			
Distance (Km) 28,500		Temps (min) 40'	Vitesse (km/h) 42,07
Kilométrage Total Partiel		DIRECTION	INFORMATION
28,500	0,300		 
	0,250		   

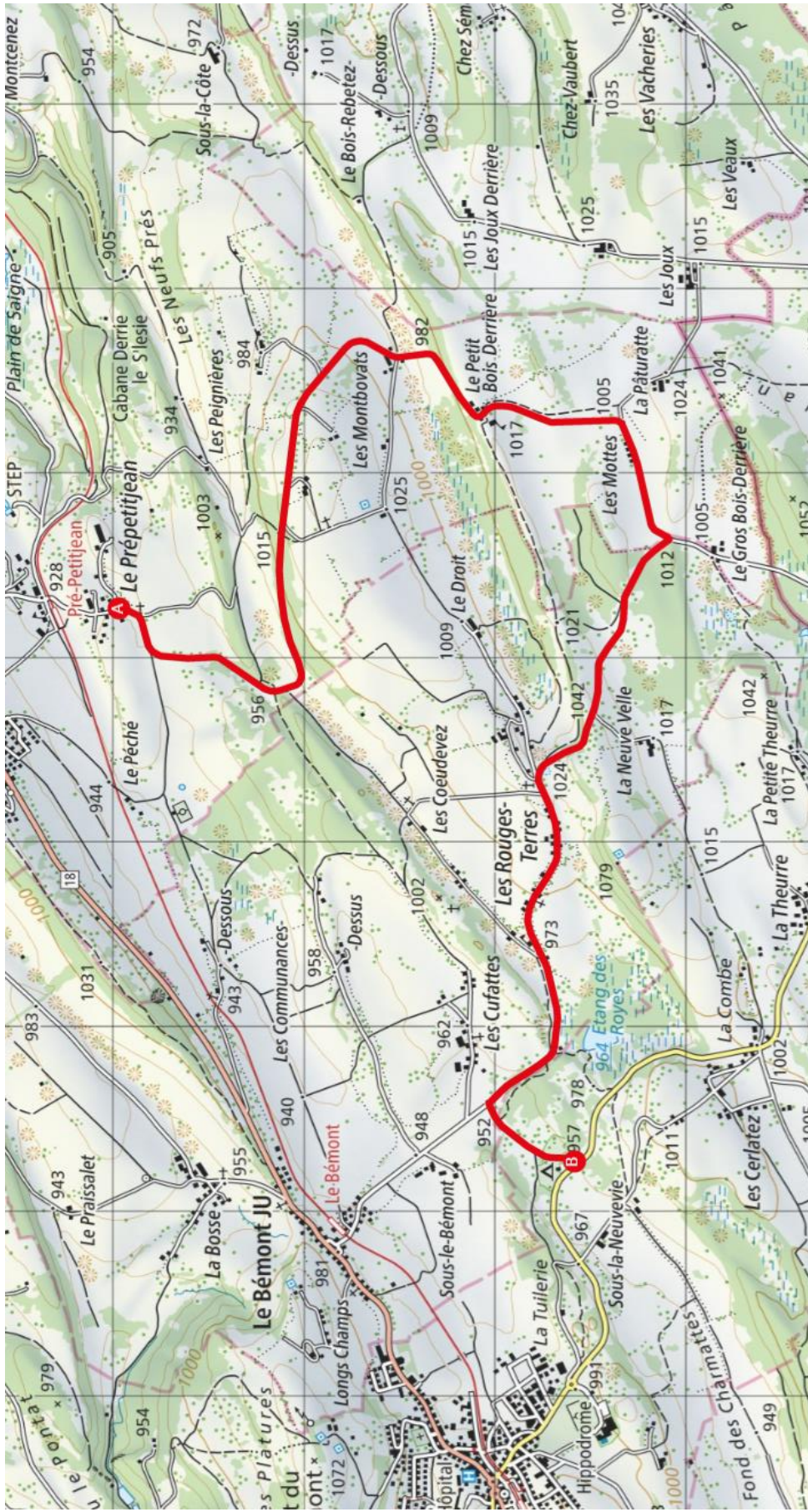



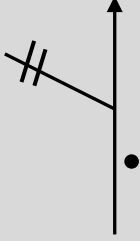

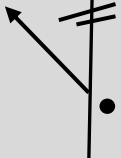
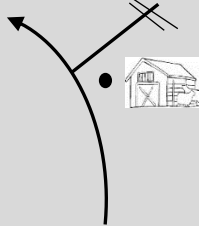
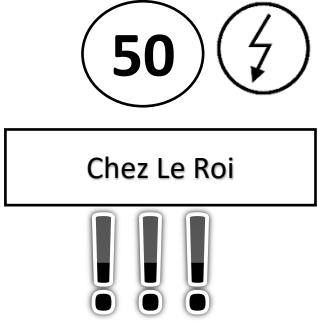
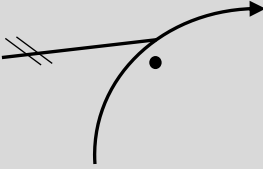
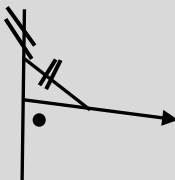
Le Prépetitjean - Le Bémont



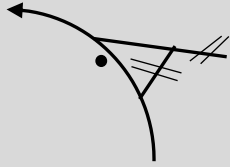
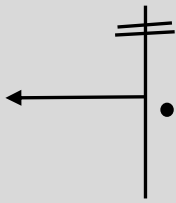

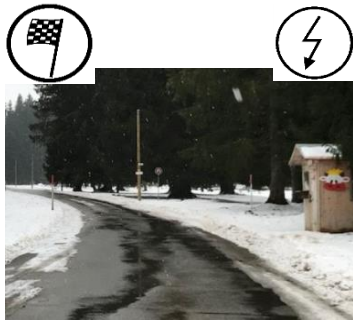
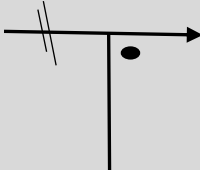

ES 8 Le Pré-Petitjean - Le Bémont			Secteur 8
CH 8 A Saignelégier			
Distance (Km) 11,550	Temps (min) 15'	Vitesse (km/h) 46,20	
Kilométrage Total Partiel	DIRECTION	INFORMATION	Distance totale

0,000	0,000	 1		11,550
0,210	0,210	 2	TDMR	11,340
3,260	3,050	 3		8,290
4,660	1,400	 4		6,890
5,350	0,690	 5	 TDMR	6,200

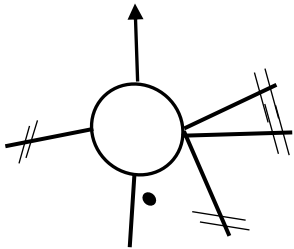
ES 8 Le Pré-Petitjean - Le Bémont			Secteur 8
CH 8 A Saignelégier			
Distance (Km) 11,550		Temps (min) 15'	Vitesse (km/h) 46,20
Kilométrage Total Partiel		DIRECTION	INFORMATION
			Distance totale
6,910	1,560	 6	TDMR
8,910	2,000	 7	
8,960	0,050	 8	
9,460	0,500	 9	

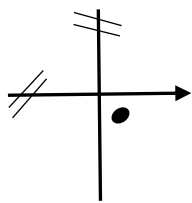



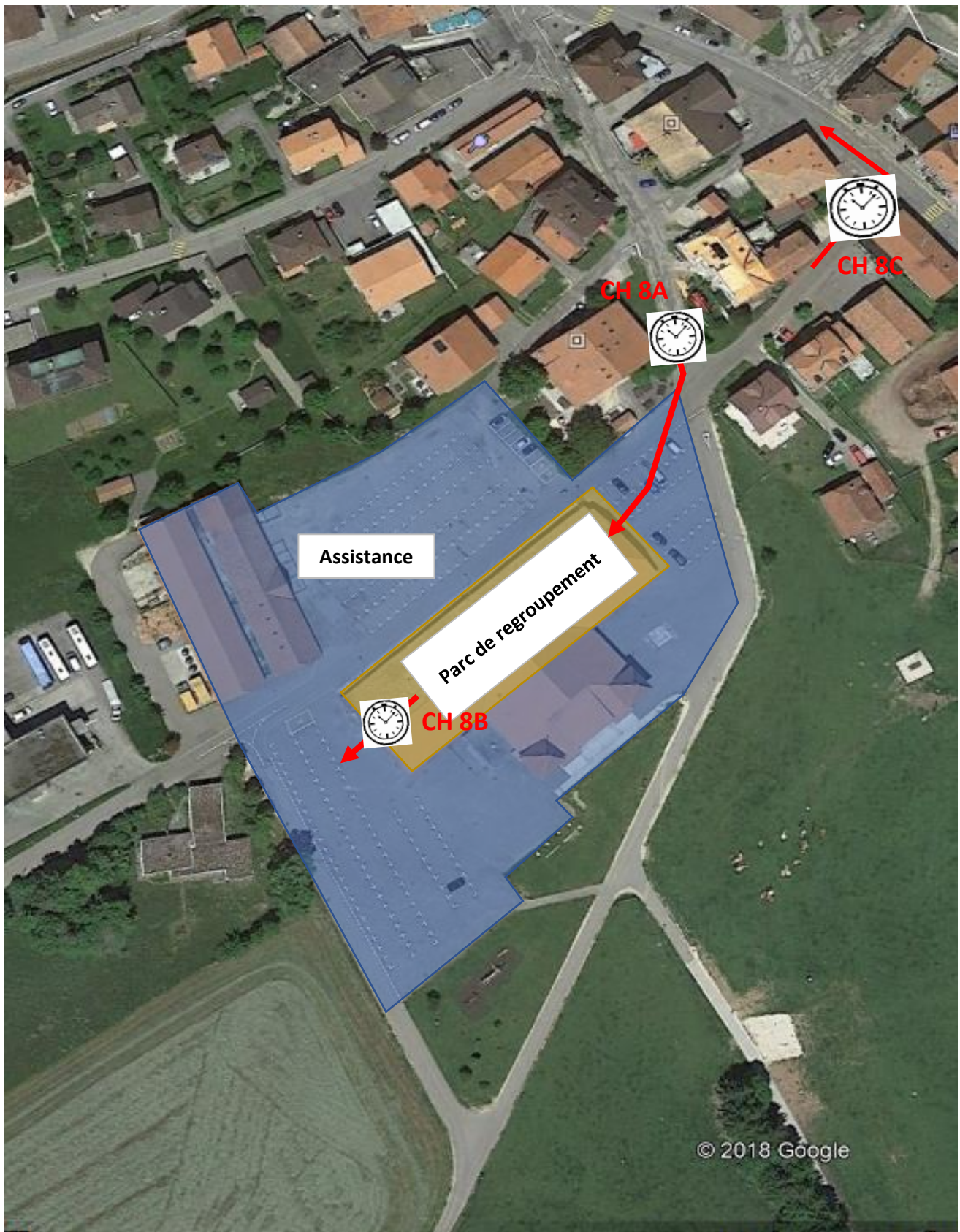

ES 8 Le Pré-Petitjean - Le Bémont			Secteur 8
CH 8 A Saignelégier			
Distance (Km) 11,550	Temps (min) 15'	Vitesse (km/h) 46,20	
Kilométrage Total Partiel	DIRECTION	INFORMATION	Distance totale



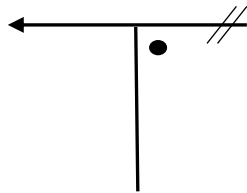

10,810	1,350	 37	TDMR	0,740
11,410	0,600	 38		0,140
11,550	0,140	 39		0,000

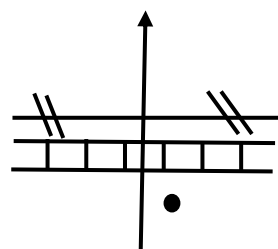
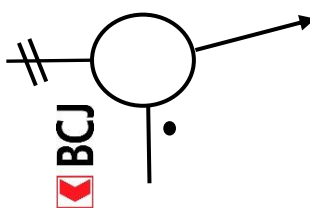
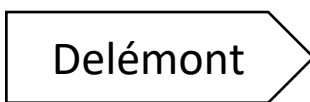
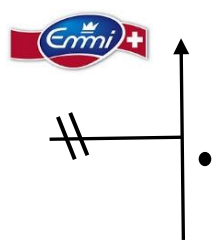



CH 8 A Entrée regroupement Saignelégier		Secteur 8A/B
CH 8 B Sortie regroupement entrée assistance Saignelégier		
CH 8 C Sortie assistance Saignelégier		
Regroupement (min) 40'	Assistance (min) 30'	

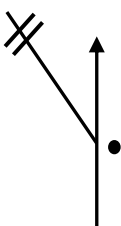
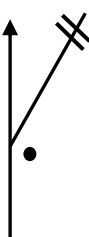



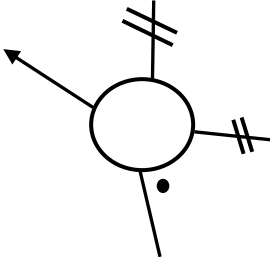
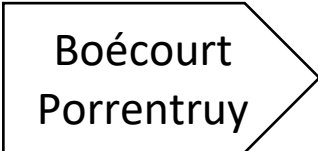
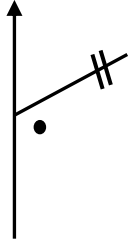
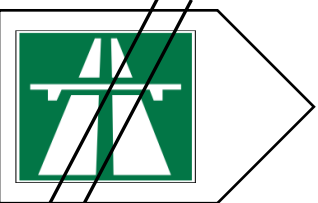

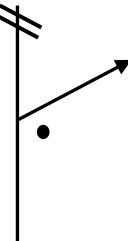
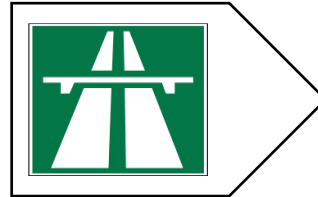
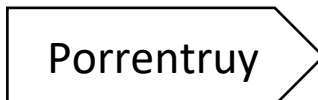
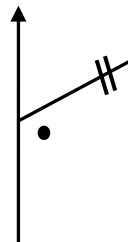
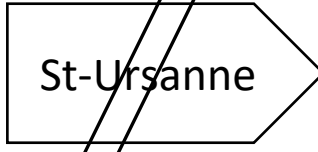
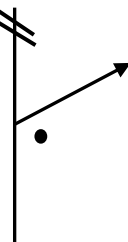
CH 8C Saignelégier			Secteur 8C
CH 9 Alle			
Distance (Km) 34,570	Temps (min) 45'	Vitesse (km/h) 46,093	
Kilométrage Total Partiel	DIRECTION	INFORMATION	Distance totale

0,000	0,000			34,570
0,040	0,040			34,530
0,190	0,150			34,380
0,260	0,070			34,310
1,130	0,870		 TDMR	33,440

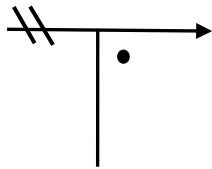
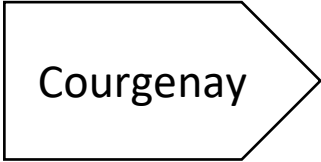
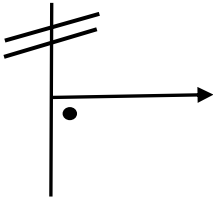
CH 8C Saignelégier			Secteur 8C	
CH 9 Alle				
Distance (Km) 34,570		Temps (min) 45'		Vitesse (km/h) 46,093
Kilométrage Total Partiel		DIRECTION	INFORMATION	Distance totale
1,460	0,330		<div style="border: 1px solid black; padding: 5px; display: inline-block;">Le Bémont</div> TDMR	33,110
4,810	3,350		<div style="border: 1px solid black; padding: 5px; display: inline-block;">Montfaucon</div> TDMR	29,760
10,560	5,750		<div style="border: 1px solid black; padding: 5px; display: inline-block;">St-Brais</div> TDMR	24,010
13,970	3,410		<div style="border: 1px solid black; padding: 5px; display: inline-block;">Delémont</div> TDMR	20,600
18,500	4,530		 <div style="border: 1px solid black; padding: 5px; display: inline-block;">Delémont</div> <div style="border: 1px solid black; padding: 5px; display: inline-block;">Glovelier</div>	16,070

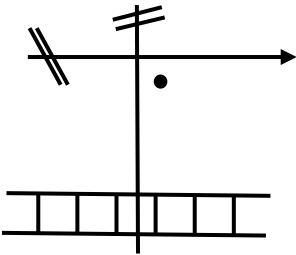
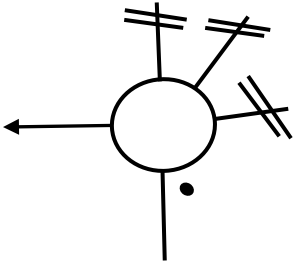
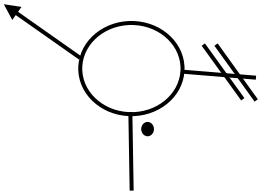
CH 8C Saignelégier			Secteur 8C	
CH 9 Alle				
Distance (Km) 34,570	Temps (min) 45'	Vitesse (km/h) 46,093		
Kilométrage Total Partiel		DIRECTION	INFORMATION	Distance totale
20,550	2,050	 11	 Boécourt Porrentruy	14,020
20,710	0,160	 12	  Delémont	13,860
20,810	0,100	 13	  Porrentruy	13,760
24,510	3,700	 14	 St-Ursanne	10,060
29,310	4,800	 15	 Courgenay	5,260

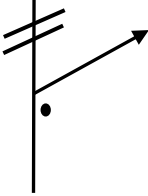
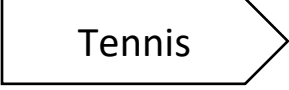
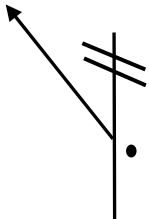
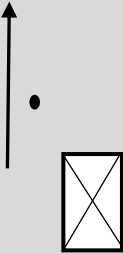
CH 8C Saignelégier			Secteur 8C	
CH 9 Alle				
Distance (Km) 34,570		Temps (min) 45'		Vitesse (km/h) 46,093
Kilométrage Total Partiel		DIRECTION	INFORMATION	Distance totale
29,840	0,530	 16		4,730
30,870	1,030	 17	 TDMR	3,700
33,110	2,240	 18		1,460
33,560	0,450	 19		1,010
33,710	0,150	 20		0,860

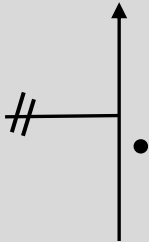
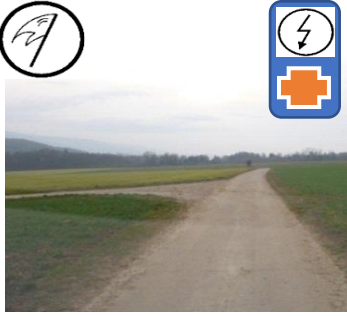





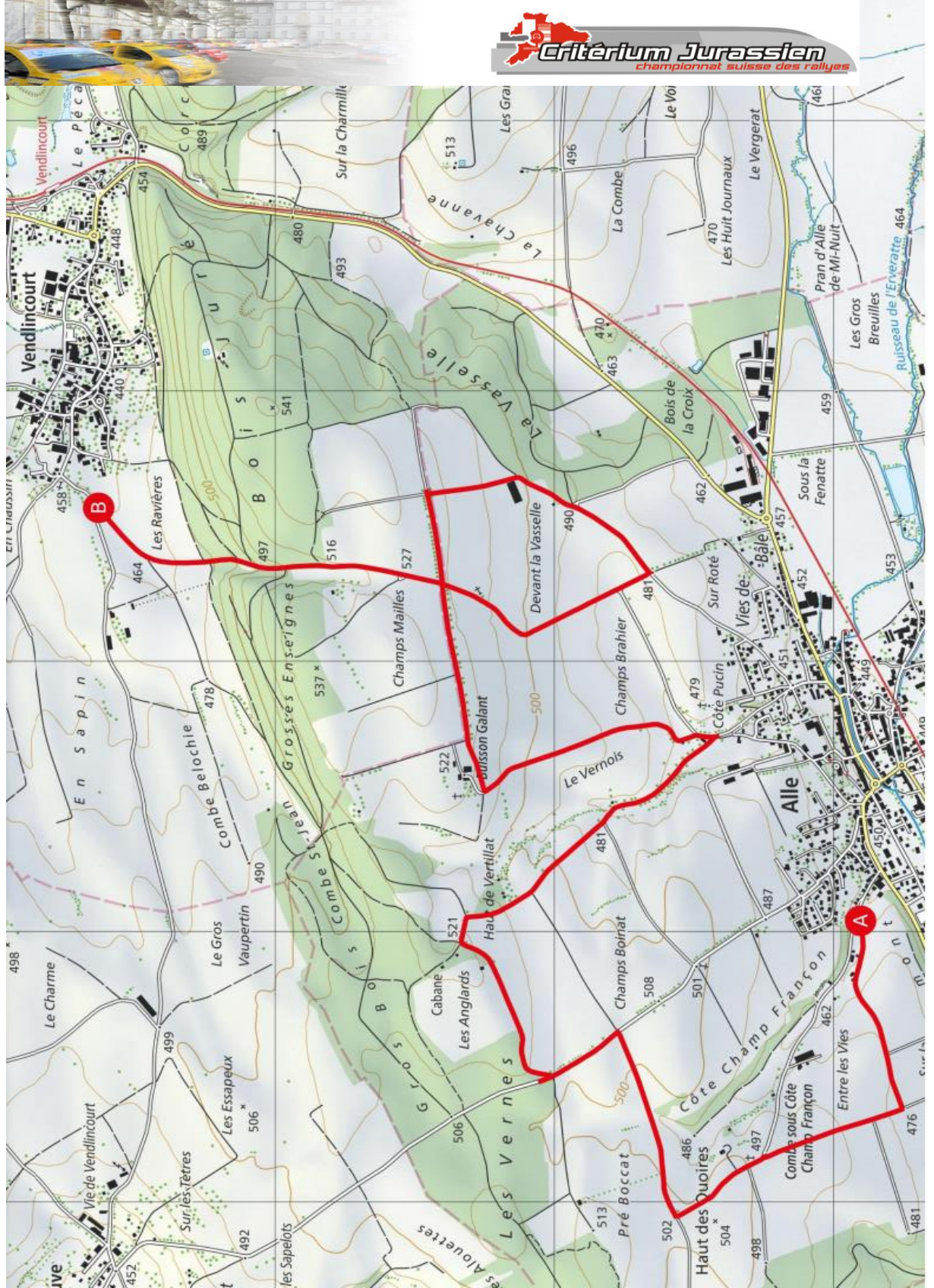

CH 8C Saignelégier			Secteur 8C	
CH 9 Alle				
Distance (Km) 34,570		Temps (min) 45'		Vitesse (km/h) 46,093
Kilométrage Total Partiel		DIRECTION	INFORMATION	Distance totale
34,070	0,360	 21		0,500
34,250	0,180	 20		0,320
34,570	0,320	 21		0,000
	0,230	 22		

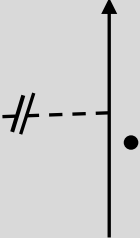

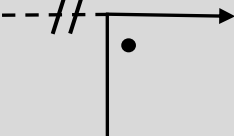
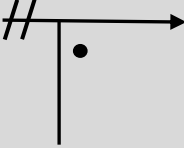

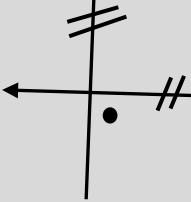

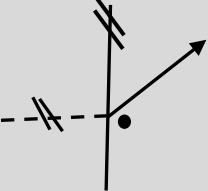

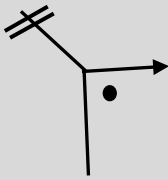

Alle - Vendlincourt

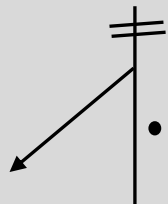

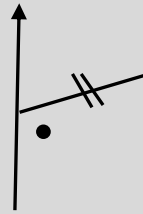
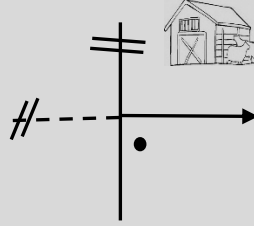

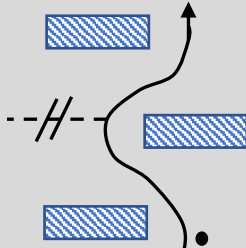

ES 9 Alle - Vendlincourt			Secteur 9
CH 10 St-Brais			
Distance (Km) 31,990	Temps (min) 40'	Vitesse (km/h) 47,98	
Kilométrage Total Partiel	DIRECTION	INFORMATION	Distance totale

0,000	0,000			37,300
0,200	0,200		TDMR	37,100
1,120	0,920			36,180
1,840	0,720			35,460
2,130	0,290			35,170

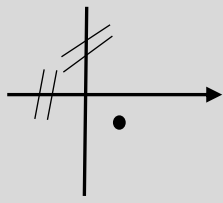

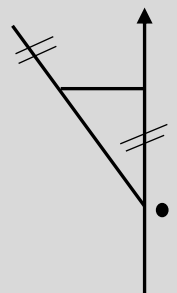
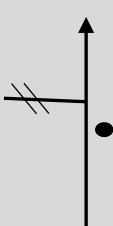
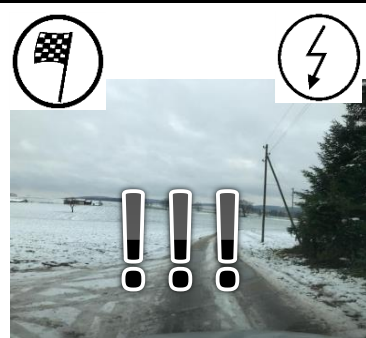
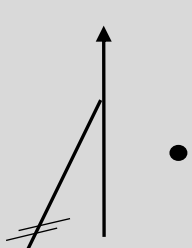



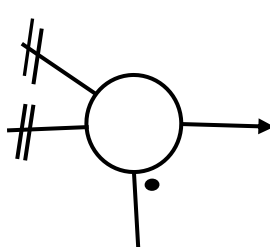
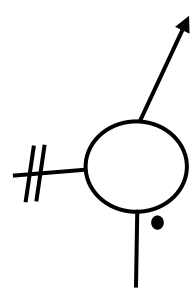
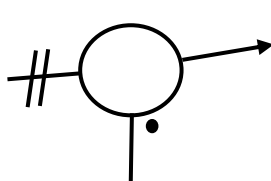
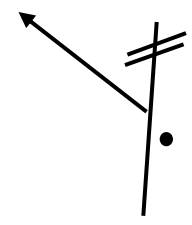
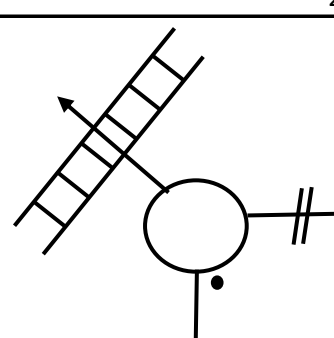
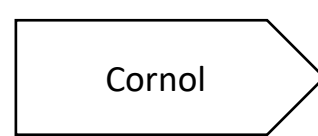

ES 9 Alle - Vendlincourt			Secteur 9	
CH 10 St-Brais				
Distance (Km) 31,990		Temps (min) 40'		Vitesse (km/h) 47,98
Kilométrage Total Partiel		DIRECTION	INFORMATION	Distance totale
2,860	0,730	 6		34,440
3,980	1,120	 7		33,320
4,040	0,060	 8		33,260
4,880	0,840	 9		32,420
5,320	0,440	 10		31,980

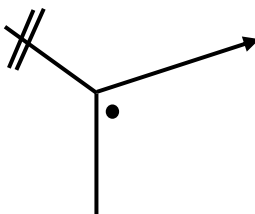

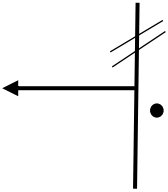

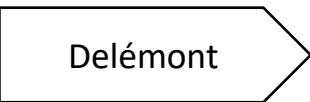
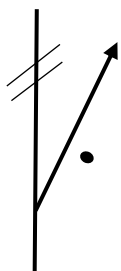

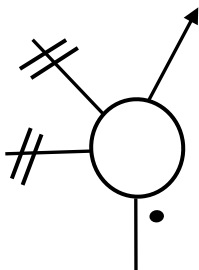

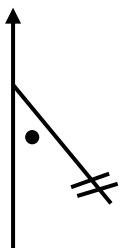
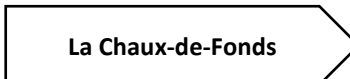
ES 9 Alle - Vendlincourt			Secteur 9
CH 10 St-Brais			
Distance (Km) 31,990	Temps (min) 40'	Vitesse (km/h) 47,98	
Kilométrage Total Partiel		DIRECTION	INFORMATION
			Distance totale
5,640	0,320	 11	 31,660
6,360	0,720	 12	30,940
6,490	0,130	 13	 30,810
6,840	0,350	 14	 30,460
7,420	0,580	 15	 29,880

ES 9 Alle - Vendlincourt			Secteur 9	
CH 10 St-Brais				
Distance (Km) 31,990		Temps (min) 40'		Vitesse (km/h) 47,98
Kilométrage Total Partiel		DIRECTION	INFORMATION	Distance totale
7,750	0,330	 16		29,550
7,870	0,120	 17		29,430
8,700	0,830	 18		28,600
9,230	0,530	 19		28,070

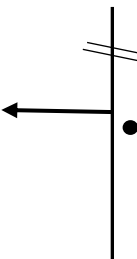
ES 9 Alle - Vendlincourt			Secteur 9
CH 10 St-Brais			
Distance (Km) 31,990	Temps (min) 40'	Vitesse (km/h) 47,98	
Kilométrage Total Partiel	DIRECTION	INFORMATION	Distance totale

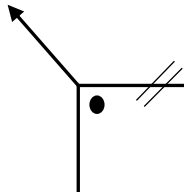
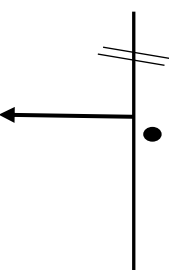
9,330	0,100	 20	TDMR	27,970
10,280	0,950	 21	TDMR	27,020
13,310	3,030	 22		23,990
14,020	0,710	 23		23,280
14,220	0,200	 24	 TDMR	23,080

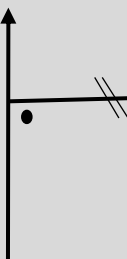
ES 9 Alle - Vendlincourt			Secteur	
CH 10 St-Brais				
Distance (Km) 31,990		Temps (min) 40'	Vitesse (km/h) 47,98	
Kilométrage Total Partiel		DIRECTION	INFORMATION	
			Distance totale	
17,130	2,910	 25	 	20,170
18,440	1,310	 26	 	18,860
27,040	8,600	 27		10,260
27,330	0,290	 28	 TDMR	9,970
33,030	5,700	 29	 TDMR	4,270

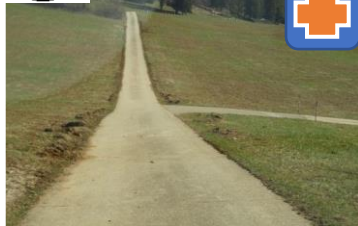

ES 9 Alle - Vendlincourt			Secteur 9	
CH 10 St-Brais				
Distance (Km) 31,990		Temps (min) 40'	Vitesse (km/h) 47,98	
Kilométrage Total Partiel		DIRECTION	INFORMATION	
			Distance totale	
35,230	2,200	 30	  TDMR	2,070
37,030	1,800	 31		0,270
37,110	0,080	 32		0,190
37,300	0,190	 33	 	0,000
	0,490	 34	  	







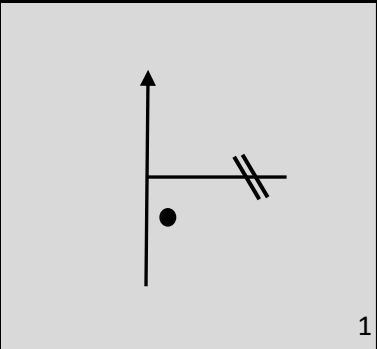
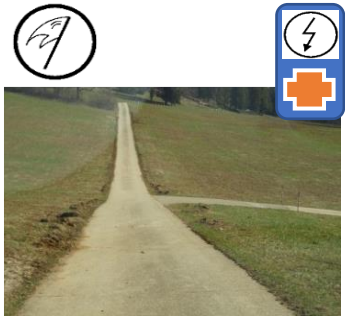

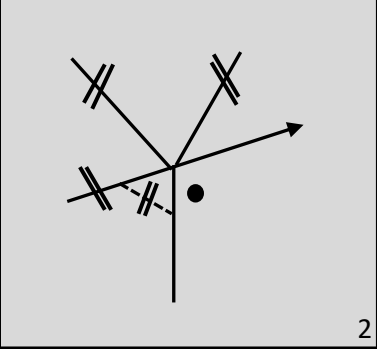
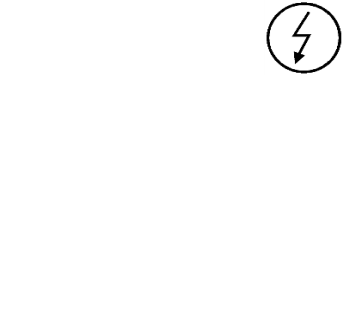
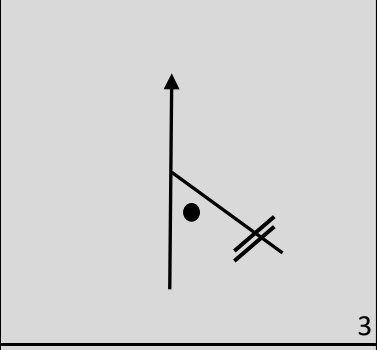
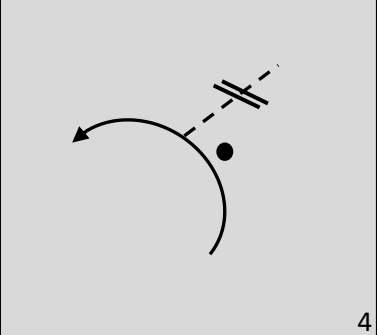
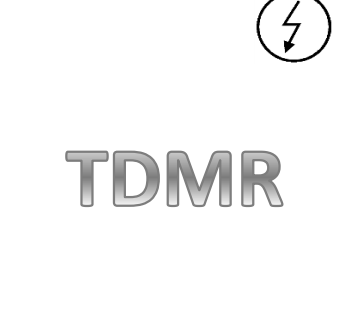

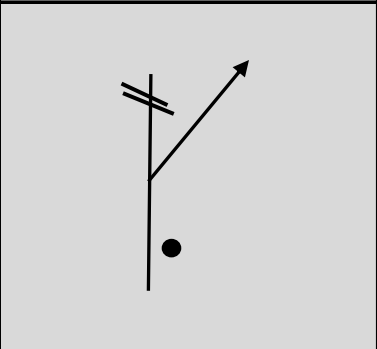
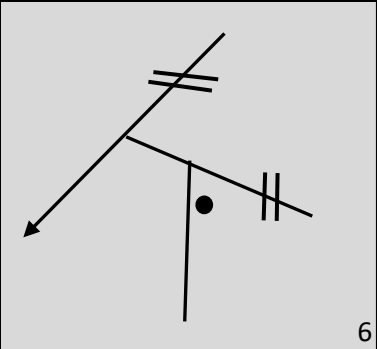

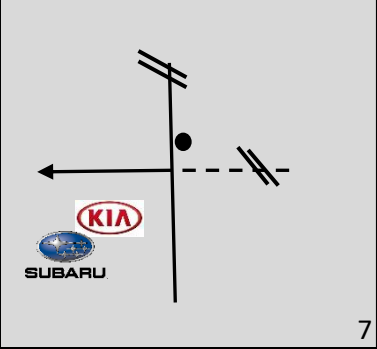
St-Brais - Saulcy

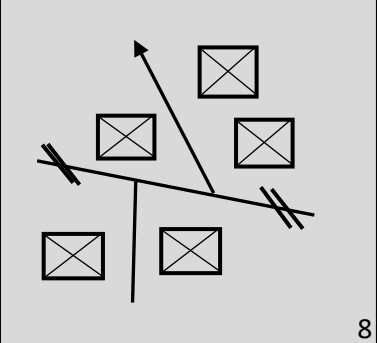



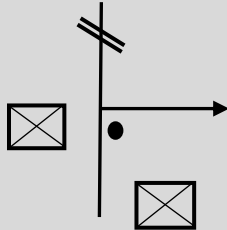

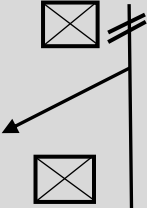

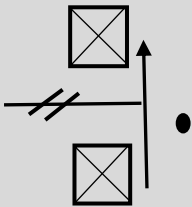

ES 10 St-Brais - Saulcy			Secteur
CH 11 Le Pré-Petitjean			
Distance (Km) 28,500		Temps (min) 40'	Vitesse (km/h) 42,07
Kilométrage Total Partiel		DIRECTION	INFORMATION
			Distance totale

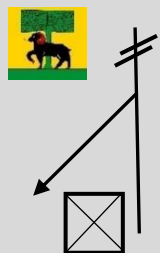

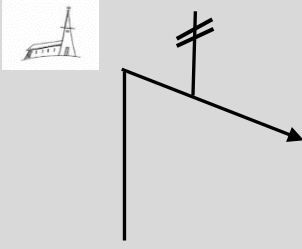

0,000	0,000		 	28,500
0,620	0,620			27,880
1,060	0,440		TDMR	27,440
3,150	2,090		 TDMR	25,350







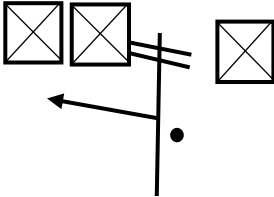

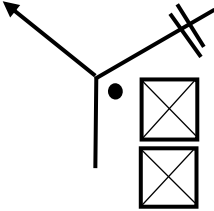
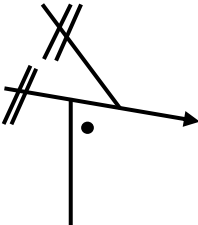
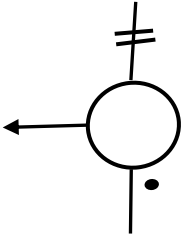
ES 10 St-Brais - Saulcy			Secteur 10	
CH 11 Le Pré-Petitjean				
Distance (Km) 28,500	Temps (min) 40'	Vitesse (km/h) 42,07		
Kilométrage Total Partiel		DIRECTION	INFORMATION	Distance totale
4,530	1,380			23,970
5,170	0,640			23,330
6,170	1,000		 	22,330
6,260	0,090			22,240

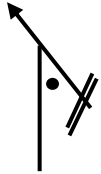

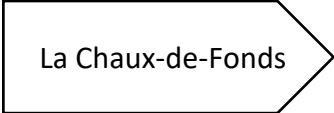
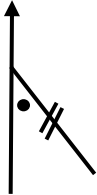
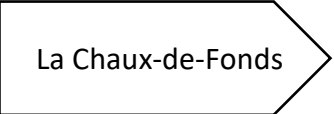
ES 10 St-Brais - Saulcy			Secteur 10	
CH 11 Le Pré-Petitjean				
Distance (Km) 28,500	Temps (min) 40'	Vitesse (km/h) 42,07		
Kilométrage Total Partiel		DIRECTION	INFORMATION	Distance totale
6,480	0,220	 9	 	22,020
6,810	0,330	 10	 	21,690
6,870	0,060	 11	 	21,630
6,890	0,020	 12	 	21,610

ES 10 St-Brais - Saulcy			Secteur 10	
CH 11 Le Pré-Petitjean				
Distance (Km) 28,500	Temps (min) 40'	Vitesse (km/h) 42,07		
Kilométrage Total Partiel		DIRECTION	INFORMATION	Distance totale
6,980	0,090	 13	 	21,520
7,020	0,040	 14	 	21,480
7,070	0,050	 15		21,430
7,130	0,060	 16	 	21,370

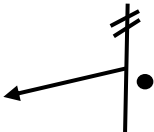
ES 10 St-Brais - Saulcy			Secteur 10
CH 11 Le Pré-Petitjean			
Distance (Km) 28,500	Temps (min) 40'	Vitesse (km/h) 42,07	
Kilométrage Total Partiel	DIRECTION	INFORMATION	Distance totale

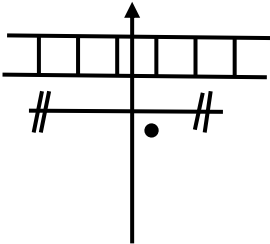
7,280	0,150		  <p>TDMR</p>	21,220
8,620	1,340			19,880
8,670	0,050			19,830
9,270	0,600			19,230
13,410	4,140		<p>TDMR</p>	15,090

ES 10 St-Brais - Saulcy			Secteur 10
CH 11 Le Pré-Petitjean			
Distance (Km) 28,500		Temps (min) 40'	Vitesse (km/h) 42,07
Kilométrage Total Partiel		DIRECTION	INFORMATION
			Distance totale
14,040	0,630	 22	  14,460
18,640	4,600	 23	 TDMR 9,860
26,640	8,000	 24	  1,860
27,140	0,500	 25	 TDMR 1,360
28,200	1,060	 26	TDMR 0,300

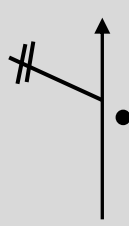
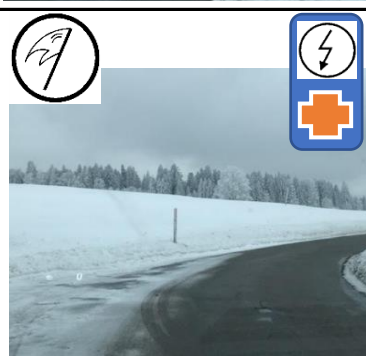



ES 10 St-Brais - Saulcy			Secteur 10
CH 11 Le Pré-Petitjean			
Distance (Km) 28,500		Temps (min) 40'	Vitesse (km/h) 42,07
Kilométrage Total Partiel		DIRECTION	INFORMATION
28,500	0,300		
	0,250		

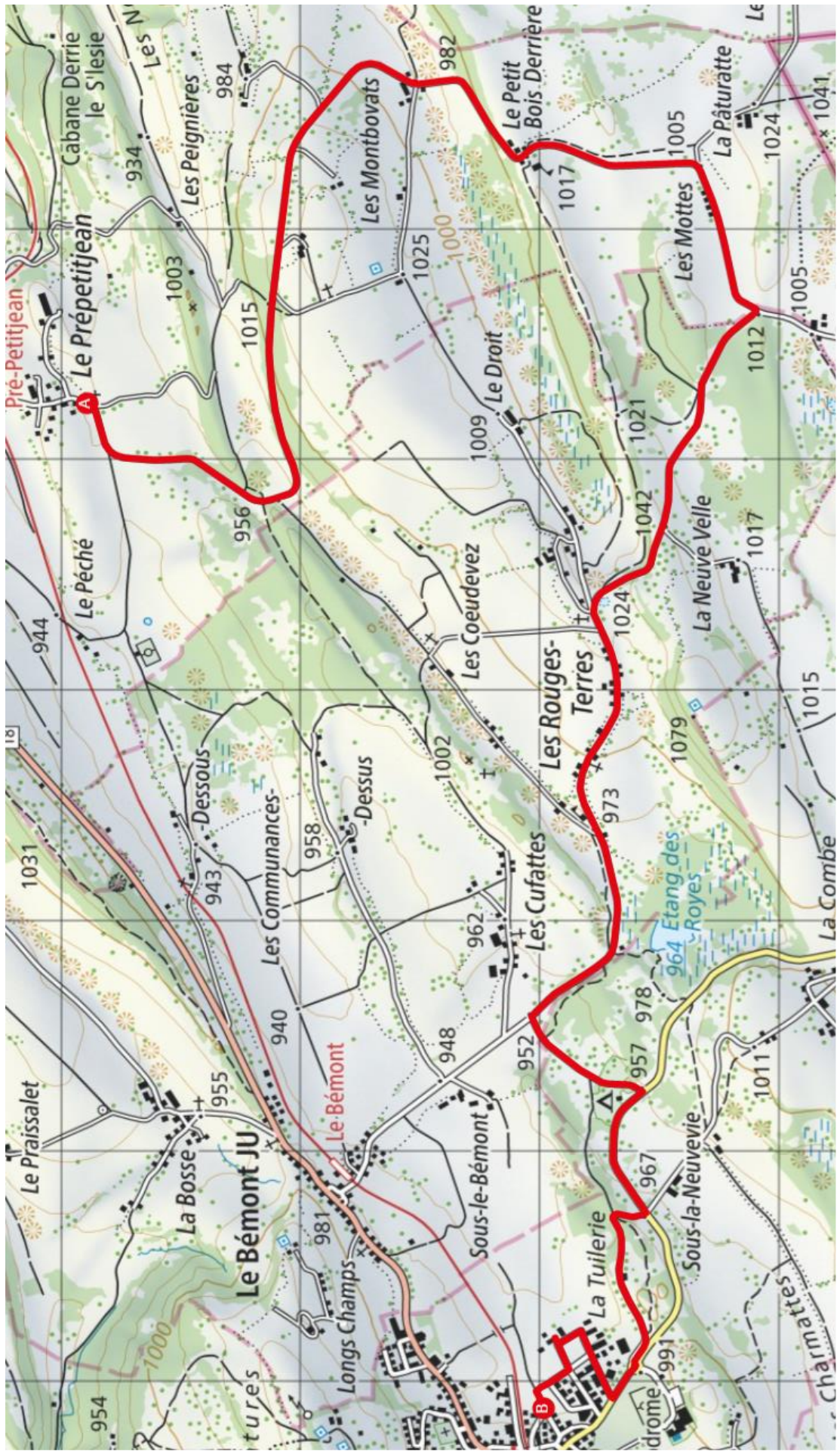



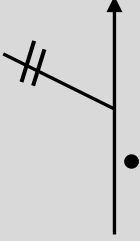

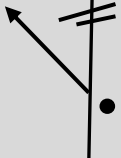
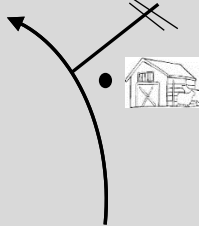
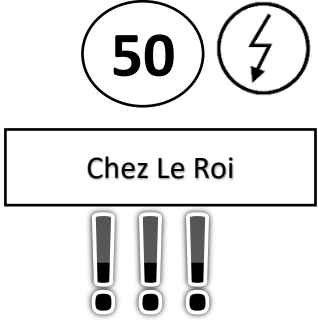
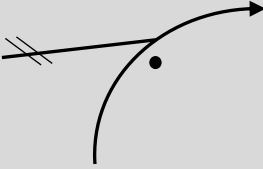
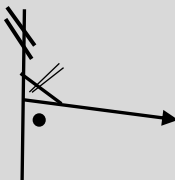



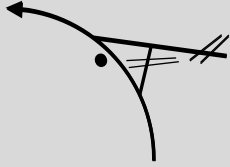
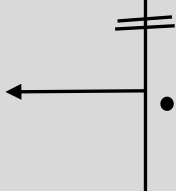

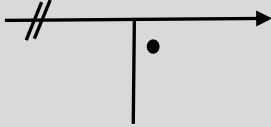

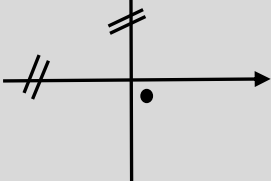

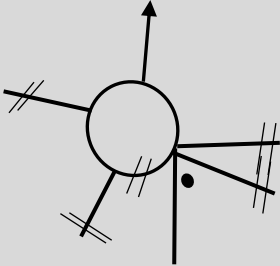

Le Prépétitjean - Saignelégier

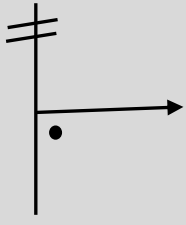

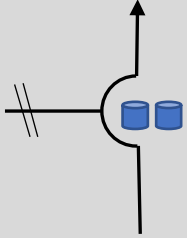

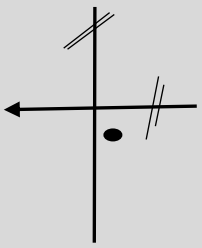
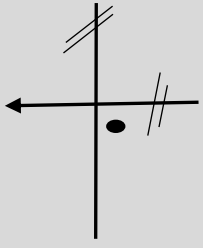

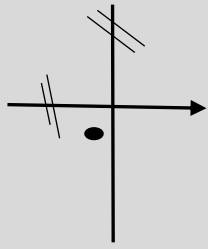
ES 11 Le Pré-Petitjean - Saignelégier			Secteur 11
CH 11 A Saignelégier arrivée finale			
Distance (Km) 11,550	Temps (min) 15'	Vitesse (km/h) 46,20	
Kilométrage Total Partiel	DIRECTION	INFORMATION	Distance totale

0,000	0,000	 1		12,340
0,210	0,210	 2	TDMR	12,130
3,260	3,050	 3		9,080
4,660	1,400	 4		7,680
5,350	0,690	 5	 TDMR	6,990

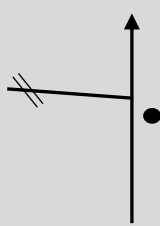
ES 11 Le Pré-Petitjean - Saignelégier			Secteur 11
CH 11 A Saignelégier arrivée finale			
Distance (Km) 11,550		Temps (min) 15'	Vitesse (km/h) 46,20
Kilométrage Total Partiel		DIRECTION	INFORMATION
			Distance totale
6,910	1,560	 6	TDMR
8,910	2,000	 7	 JUMP
9,460	0,550	 8	
10,070	0,610	 9	
10,890	0,820	 10	

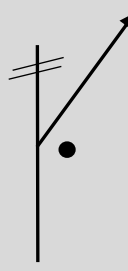
ES 11 Le Pré-Petitjean - Saignelégier				Secteur 11
CH 11 A Saignelégier arrivée finale				
Distance (Km) 11,550		Temps (min) 15'	Vitesse (km/h) 46,20	
Kilométrage Total Partiel		DIRECTION	INFORMATION	Distance totale
11,070	0,180	 11		1,270
11,270	0,200	 12		1,070
11,380	0,110	 13		0,960
11,490	0,110	 14		0,850
11,610	0,120	 15		0,730

ES 11 Le Pré-Petitjean - Saignelégier			Secteur 11	
CH 11 A Saignelégier arrivée finale				
Distance (Km) 11,550		Temps (min) 15'	Vitesse (km/h) 46,20	
Kilométrage Total Partiel		DIRECTION	INFORMATION	
			Distance totale	
11,710	0,100	 16	 	0,630
11,970	0,260	 17	 	0,370

ES 11 Le Pré-Petitjean - Saignelégier			Secteur 11
CH 11 A Saignelégier arrivée finale			
Distance (Km) 12,340	Temps (min) 15'	Vitesse (km/h) 49,36	
Kilométrage Total Partiel	DIRECTION	INFORMATION	Distance totale

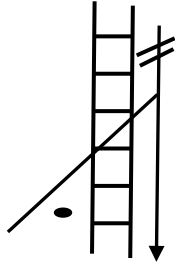
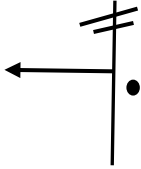
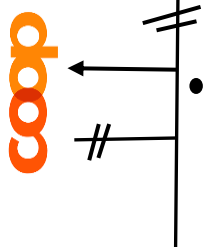
12,150	0,180	 18	0,190
12,300	0,150	 19	0,040
12,340	0,040	 20	0,000

FELICITATIONS